



# American Hanger

and Fixture Corporation

**Hangers**

**Bags**

**Mannequins**

**Showcases**

**Tags**

**Boxes**

**Fixtures**



**PIPELINE FIXTURES**  
(See page 44-45)



**12/FFB  
BRAZILIAN  
FULL FORM**  
(See page 72)



**VINYL COVERS**  
(See page 26, 27)



**P70G  
GOLD AND SILVER  
PLATED HANGERS**  
(See page 5)



**FROSTED SHOPPING BAGS**  
(See page 95-98)

**[www.americanhanger.com](http://www.americanhanger.com)**

**Toll Free (800) 221-2790 • NJ (908) 688-6100 • Fax (908) 687-1770**

**Email: [sales@americanhanger.com](mailto:sales@americanhanger.com)**



# American Hanger

and Fixture Corporation

<b>3-22</b>	<b>Hangers – Plastic, Wood, Display, Metal</b>
<b>23-28</b>	<b>Garment Protectors – Zippered Bags, Polly Bags, Hanger Accessories, Steamers</b>
<b>29-45</b>	<b>Garment Racks – Gondolas, Shoe Fixtures, Rack Systems</b>
<b>46-50</b>	<b>Faceout Display Hardware – Waterfalls, Sign Frames, Bulletin Signs</b>
<b>51-58</b>	<b>Slatwall &amp; Gridwall Accessories – Slatwall Fixtures, Slatgrid, Outriggers, Gridwall</b>
<b>59-62</b>	<b>Glass Display Merchandisers – Grid Cubes, Acrylic Displayers, Pegboard Display, Mirrors</b>
<b>63-68</b>	<b>Wall Display Systems – Standards, Brackets, Shelving, Tables, Baskets</b>
<b>69-78</b>	<b>Mannequins &amp; Display Forms – Jersey Covered Forms, Torso Forms, Accessory Displays</b>
<b>79-80</b>	<b>Showcases – Register Stands, Counters</b>
<b>81-86</b>	<b>Sales Aids &amp; Helpers – Counter Fixtures, Jewelry Display, Security Items</b>
<b>87-94</b>	<b>Tagging &amp; Labeling – Marking Guns, Dividers, Tags, Fasteners</b>
<b>95-98</b>	<b>Packaging – Bags, Boxes, Tissue</b>

## Quick Find INDEX

Acrylic Displayers .....	53, 58, 61	Grid Cubes .....	60	Safety Pins .....	91
Alteration Tags .....	90, 91	Gondolas .....	39, 43	Sale Tags .....	90-94
Bags, Carry Out .....	95-98	Gown Bags .....	22, 23, 27	Sales Books .....	84
Bags, Garbage .....	81	Gridwall and Accessories .....	54-58	Salesman's Rack .....	21, 30
Bags, Poly on Rolls .....	22, 23	Guns .....	88, 89	Salesman Supplies .....	21, 24-28, 30
Baskets, Display .....	40, 56, 57, 67, 68	Handbag Rack .....	39	Sale Signs .....	50
Baskets, Shopping .....	86	Hangers .....	3-21	Security Cameras .....	86
Belt Racks .....	39	Hangers Display .....	3-21	Security Devices .....	86
Belt Hangers .....	84	Hanger Stackers .....	4	Shelf Brackets .....	65
Boot Hangers .....	11	Hat Forms .....	78	Shelving .....	67
Boxes .....	98	Hat Rack .....	40, 43	Shoe Display .....	40, 44, 45, 51, 53, 56, 58, 61
Brackets .....	51, 54, 55, 63-66	Hosiery Forms .....	78	Shoe Measurer .....	61
Bridal Bags on Rolls .....	22, 23	Hosiery Racks .....	35, 40	Shoe Racks .....	40, 45
Bridal, Zipper Bags .....	27	Jersey Covered Forms .....	71, 72	Shopping Bags .....	95-98
Bulletin Signs .....	50	Jewelry Displayers .....	83	Shopping Baskets .....	86
Cameras .....	86	Jewelry Tags .....	94	Shopping Carts .....	86
Cardholders .....	48-50	Knives .....	84	Shoulder Covers .....	23, 26
Carts, Shopping .....	90	Labelers .....	88	Showcases .....	79, 80
Cash Register .....	94	Labels .....	12, 85, 88, 90	Signs Holders .....	48-50
Cleaning Products .....	28	Lay-Away Tags .....	90, 91	Signs .....	50
Counter Fixtures .....	70, 82, 83	Lingerie Racks .....	37, 40	Size Divider .....	85, 87
Counters .....	79, 80	Mannequins .....	69-78	Stain Remover .....	27
Covers .....	21-27	Markers .....	89, 91	Slatwall and Accessories .....	51-53
Display Forms .....	7, 69-78	Men's Forms .....	7, 71-77	Standards and Brackets .....	63-66
Display Stands & Bases .....	69-71	Mirrors .....	59, 82	Stand, Chrome .....	70-72
Dividers, Size .....	85, 87	Outriggers .....	42, 44, 54	Staple Guns .....	84
Door Mats .....	86	Pegboard Hooks .....	62	Steamers .....	28
Eyeglass Display .....	78	Pennants .....	81	Stickers .....	12, 88, 90, 94
Fasteners, Plastic .....	89	Pin Tickets .....	91	Tables .....	42, 68
Fixtures, Floor .....	29-45	Pins .....	91	Tag Guns .....	88, 89
Foam Pad Covers .....	25, 26	Pipeline Collection .....	44, 45	Tags & Labels .....	12, 90-94
Forms, Display .....	7, 69-78	Poly Bags on Rolls .....	22, 23	Tape, Sealing .....	84
Garbage Bags .....	81	Poly Bag Dispenser .....	24	Tissue Paper .....	98
Garment Covers .....	21-27	Price Markers .....	88	Tubing, Chrome .....	54, 63, 64, 66, 67
Grid Display .....	54-58	Printing on Hangers .....	12	Vacuum Cleaners .....	94
Gift Boxes .....	98	Racks .....	29-45	Vinyl Covers .....	24, 26, 27
Gift Paper Cutters .....	98	Rack Tops .....	33, 34, 37	Waterfall Displayers .....	31, 46, 47, 54, 55, 62, 63, 66
Glass Cubes .....	59, 60	Recessed Standards .....	66	Wall Fixtures .....	51, 54, 55, 62-66
Glass Shelves .....	67	Rectangular Tubing .....	66	Wheels .....	34
Glove Display .....	78	Rolling Racks .....	29-41	Zipper Bags .....	26, 27

# THE BEST QUALITY AT THE LOWEST PRICES

## Combine Items for Quantity Lower Pricing!!

**CHOICE OF CRYSTAL CLEAR, NEUTRAL OPAQUE HI-IMPACT WHITE, OR BLACK**

COMPARE OUR PRICES • IMMEDIATE DELIVERY • ALL VIRGIN PLASTICS  
STEEL REVOLVING HOOKS • SAMPLES SENT ON REQUEST • MONEY BACK IF NOT SATISFIED  
THE FINEST LINE OF HANGERS AVAILABLE TODAY! • OUR QUALITY AND PRICES CANNOT BE BEAT!

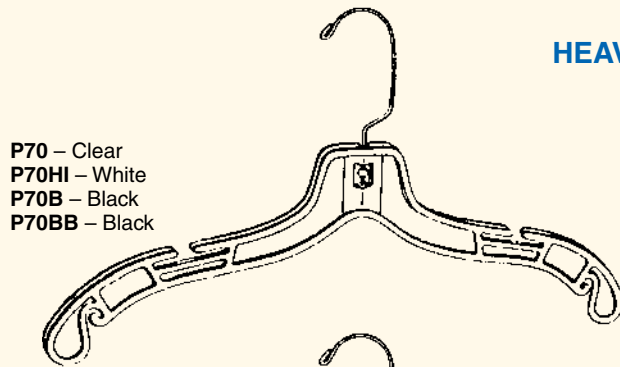

**P70** – Clear  
**P70HI** – White  
**P70B** – Black  
**P70BB** – Black

### HEAVYWEIGHT 17" DRESS HANGER

**P70** – Crystal Clear / Silver hook  
**P70HI** – Hi-Impact White / Silver hook  
**P70B** – Black / Silver hook  
**P70BB** – Black / Black hook

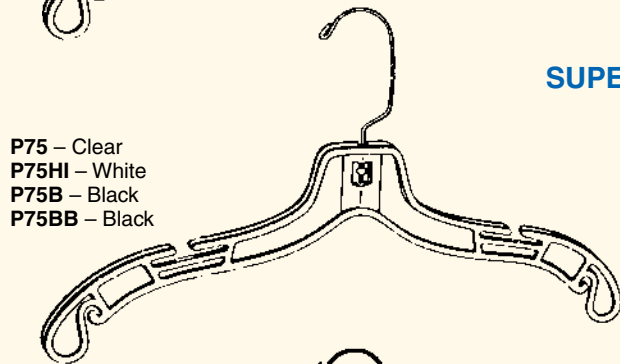

**P75** – Clear  
**P75HI** – White  
**P75B** – Black  
**P75BB** – Black

### SUPER HEAVYWEIGHT 17" DRESS HANGER

**P75** – Crystal Clear / Silver hook  
**P75HI** – Hi-Impact White / Silver hook  
**P75B** – Black / Silver hook  
**P75BB** – Black / Black hook

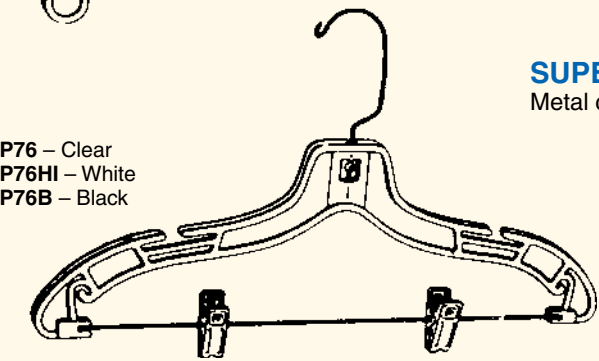

**P76** – Clear  
**P76HI** – White  
**P76B** – Black

### SUPER HEAVYWEIGHT 17" SUIT HANGERS

Metal clips with rubber vinyl inserts

**P76** – Crystal clear / Silver hook  
**P76HI** – Hi-impact white / Silver hook  
**P76B** – Black / Silver hook

**P76BBR** – Black / Black hook  
(Saks approved) (See page 5).

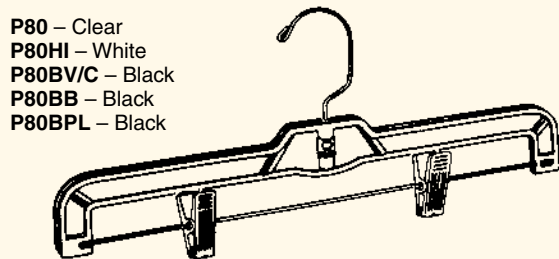

**P80** – Clear  
**P80HI** – White  
**P80BV/C** – Black  
**P80BB** – Black  
**P80BPL** – Black

### SUPER HEAVYWEIGHT 14" SKIRT HANGER

Heavy duty metal clips with rubber vinyl inserts

**P80** – Crystal Clear / Silver hook  
**P80HI** – Hi-Impact White / Silver hook  
**P80BV/C** – Black / Silver hook & metal clips  
**P80BB** – Black / Black hook & Black plastic clips  
**P80BPL** – Black / Silver hook & bar, Black plastic clips

**P80BBR** – Black / Black hook, bar and plastic clips.  
(Saks approved) (See page 5).

All metal clip hangers have rubber vinyl inserts in the clip to prevent marks on garment.  
We also supply matching color plastic clips for **P80BB** and **P80BPL**.

# THE BEST HANGER BUYS ON THE MARKET

Choice of crystal clear, neutral opaque hi-impact white or black.

Steel revolving hooks – Girder construction for rigid strength

Samples on request! – Compare and save!

## SUPER HEAVYWEIGHT 17" COAT HANGER

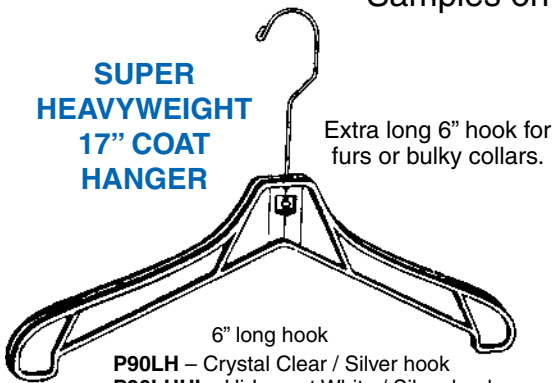

Extra long 6" hook for furs or bulky collars.

6" long hook

- P90LH – Crystal Clear / Silver hook
- P90LHHI – Hi-Impact White / Silver hook
- P90BLH – Black / Silver hook
- P90BBLH – Black / Black hook

## SUPER HEAVYWEIGHT 17" LADIES COAT OR SWEATER HANGERS

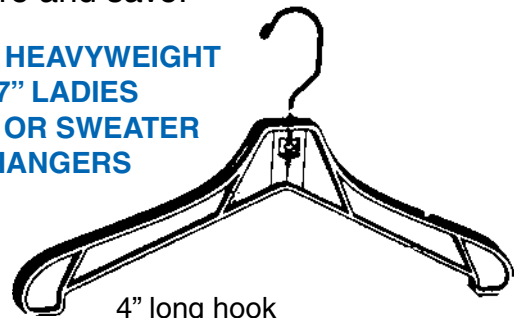

4" long hook

- P90SH – Crystal clear / Silver hook
- P90SHHI – Hi-impact white / Silver hook
- P90B – Black / Silver hook
- P90BB – Black / Black hook

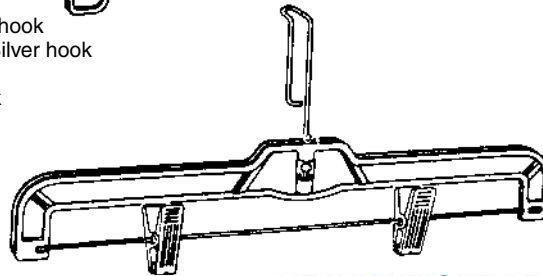

## HEAVYWEIGHT DROP ATTACHMENT 14" WIDE

Metal clips with rubber vinyl inserts

- P81 – Crystal clear / Silver hook
- P81HI – Hi-impact white / Silver hook

## All Chrome HANGER STACKER

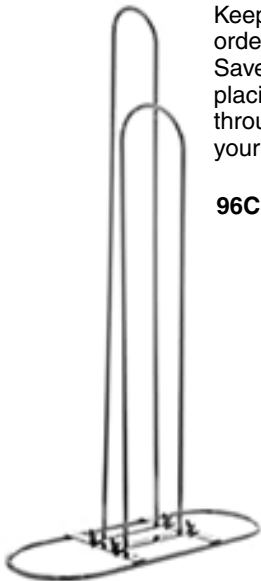

Keep hangers neat, in order and unbroken. Save time and money by placing these handy units throughout your store & at your cash counter.

96C

## HANGER REUSE SYSTEM

### Prevent clutter behind check out area!

Collect hangers on Cashwrap Rack. Remove full bar of hangers and store in backroom for reuse.

### Kit Includes:

- 1 Backroom Storage Rack, 78" high
- 1 Cashwrap Collection Rack, 40" high
- 10 removable Hangrails, 24" long

Shipped 1 kit per box UPS

HRS96

## CHROME HANGER CADDY

CHC30 – 31" high x 30" long, 3 bars to keep hanger styles separate and easy to recycle. Wheels.

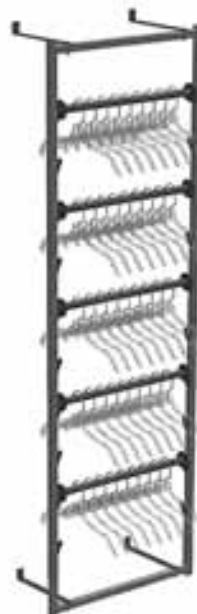

Backroom Storage Rack

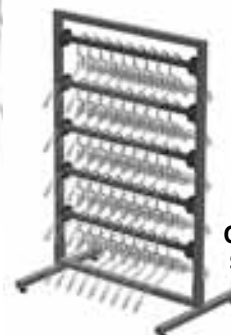

Cashwrap Collection and Storage Rack



Hangbar



## GOLD PLATED HANGERS

P71G, P80G use vinyl cushioned metal clips only.

Matching gold hooks.



P70G – Gold dress hanger



P80G – Gold skirt hanger



P71G – Gold skirt hanger

## SILVER PLATED HANGERS

P71S, P80S use vinyl cushioned metal clips only.

Matching silver hooks.



P70S – Silver dress hanger



P80S – Silver skirt hanger



P71S – Silver suit hanger

### 14" SKIRT HANGER

Choice of  
Silver or  
Black Hook



P80BV/C – Black/Silver hook  
Silver metal clips

P80BPL – Black/Silver hook and bar  
Matching black plastic clip

P80BB – Black/Black hook, Silver  
bar, Matching black plastic clip

P80BBR – Black/Black ball end  
hook. Black bar, Black plastic clips.

## BLACK HANGERS

### TRUFORM HANGERS IN JET BLACK

Jet black hangers to enhance any decor... Their eye-catching beauty creates a smashing visual impact.

Matching black hooks available on P70BB and P80BB, and P76BBR (black bar, black plastic clips, and rubber on ends). P70BR also has rubber on ends. See matching coat hanger (P90BB – page 4, 19).



P76B  
P76BBR

P76BBR – Black bar, hook  
and black plastic clips.  
Rubber on ends.

P76B – Black/Silver hook  
and bar. Metal clips with  
vinyl inserts



### HEAVYWEIGHT 17" DRESS HANGER

Choice of Silver or  
Black Hook

P70B – Black/silver hook

P70BB – Black/black hook

P70BBR – Black/black hook,  
Rubber on ends

### HEAVYWEIGHT 17" SUIT HANGER

### SUPER HEAVYWEIGHT 17" SUIT HANGER

(Saks Approved)

(Saks Approved)

(Saks Approved)

## SATIN COVERED HANGERS

### ADULT AND CHILDREN SIZE



### LADIES

SCH16 – Puffed up satin-covered top hanger. Matching color vinyl-covered hook. Colors: bone, white, black & light blue. Special colors upon request. 15-1/2" wide.

SCH16B – Bone 15-1/2" wide  
SCH16W – White 15-1/2" wide  
SCH16BK – Black 15-1/2" wide  
SCH16BL – Light Blue 15-1/2" wide

Children's 10" Wide  
Now Available

### CHILDREN

SCH10W – White 10" wide top hanger  
with matching color vinyl-covered hook.



Now  
Available  
in Black

SCH16V/C – Puffed up satin-covered suit hanger with skirt clips. Matching color vinyl-covered hook. Colors: bone, white & black. Chrome bar & clips. Special colors upon request. 15-1/2" wide.

SCH16V/CB – Bone 15-1/2" wide  
SCH16V/CW – White 15-1/2" wide  
SCH16V/CBK – Black 15-1/2" wide

# DISPLAY HANGERS

## "FOR THAT EXTRA TOUCH"

All hangers use 4" or 6" chrome hook.  
 Special colors available: pewter, clear, beige, tortoise & custom colors. For gold, black, or white hook, add 25¢ to price.  
 Heavy, durable plastic construction.  
 On orders of 100, have your logo or trademark embossed on each hanger at no charge.



### 100 THIN LINE

15 1/2" wide, 1 1/2" thick, 6" or 4" hook.  
 The perfect display hanger for sportswear.

- 100B – Black
- 100W – White
- 100G – Mustard Gold Color
- 100P – Pewter Gray
- 100BE – Beige

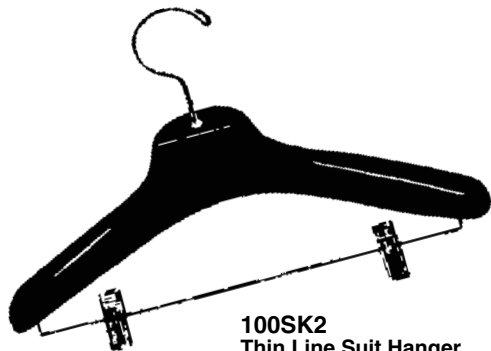

**100SK2**  
 Thin Line Suit Hanger  
 15 1/2" wide, 1 1/2" thick, 6" or 4" hook.

25 Hanger Minimum.



**P98**  
 A full 2 1/2" thick, really fills out those shoulders. Proven best-seller for window display. Available in black, white or pewter. 15 1/2" wide.

- P98B – Black
- P98W – White

## DISPLAY LARGER SIZES

Full 17-1/2" wide  
 or 19" wide (style 400B)  
 1-1/2" thick display hangers.  
 Style 300 - 17-1/2" wide.  
 Style 400B - 19" wide.

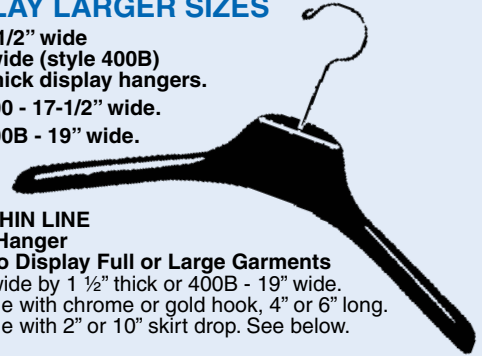

**300 – THIN LINE**  
 Dress Hanger  
 Made to Display Full or Large Garments  
 17 1/2" wide by 1 1/2" thick or 400B - 19" wide.  
 Available with chrome or gold hook, 4" or 6" long.  
 Available with 2" or 10" skirt drop. See below.

**SUIT HANGER 2" DROP**  
**300SK2** – 17 1/2" wide by 1 1/2" thick with 2" drop skirt attachment. Chrome or gold hook, 4" or 6" long. (See 100SK2 on left for illus.)

**SUIT HANGER 10" DROP**  
**300SK10** – 17 1/2" wide by 1 1/2" thick with 10" drop skirt attachment. Chrome or gold hook, 4" or 6" long. (See 100SK10 below for illus.)

## SUIT HANGER

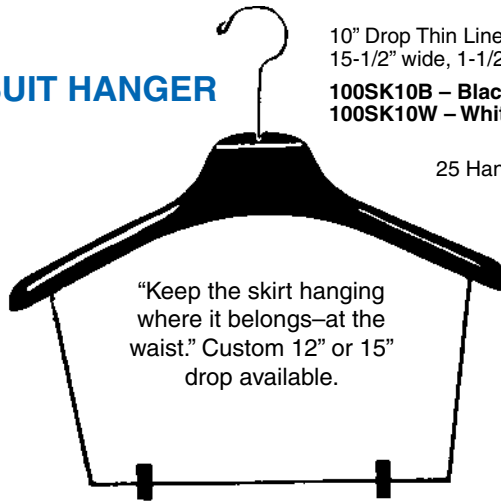

10" Drop Thin Line Suit Hanger.  
 15-1/2" wide, 1-1/2" thick, 4" or 6" hook.

- 100SK10B – Black
- 100SK10W – White

25 Hanger Minimum.

"Keep the skirt hanging where it belongs—at the waist." Custom 12" or 15" drop available.

## GREAT FOR DISPLAY OR FOR STORAGE

**FUR3** – 16-1/2" wide, 1-3/8" thick at ends. Black, Silver hook.



# HALF ROUND DISPLAY FORMS

Expensive looking matte black & matte white colored forms.  
7" depth. Matching color swivel hook. Heavy duty.  
Mens, womens or kids.



**FULL TORSO  
MEN (30" High)**  
MHR26/W – White  
MHR26/B – Black

**LADIES (30" High)**  
LHR15/W – White  
LHR15/B – Black

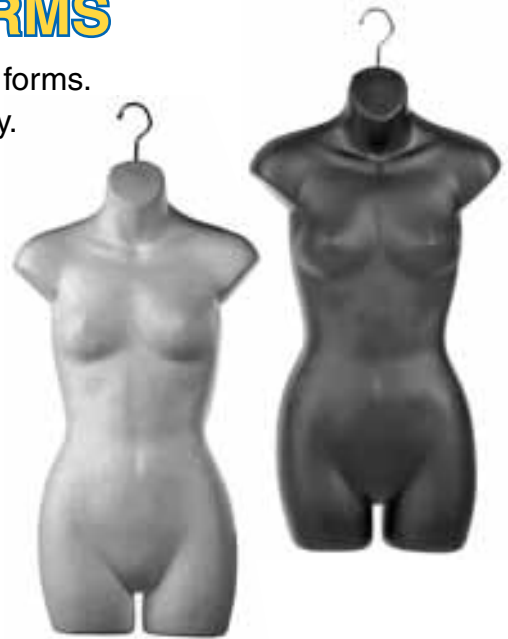

**UPPER TORSO  
MENS SHIRT**  
MHR35/W – White  
MHR35/B – Black



**UPPER TORSO**  
LHR35/W – White  
LHR35/B – Black

Also available  
in chrome.



This model also  
available in teen size.

**CHILD**  
CHR4/W – White  
CHR4/B – Black



**HIP FORM**  
LHR32/W – White  
LHR32/B – Black

# JUNIOR & KIDDIE HANGERS

(SWIVEL METAL HOOK)

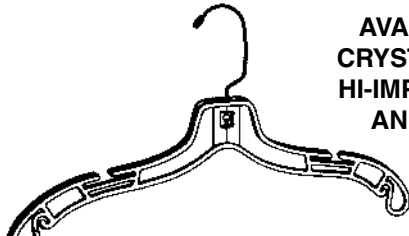

**DRESS HANGER**  
**JUNIOR 14" HEAVYWEIGHT DRESS**  
 (Fits Sizes 7-14)  
 P29 – Clear / Silver hook  
 P29B – Black / Silver hook  
 P29BB – Black / Black hook  
 P29HI – Hi-Impact White / Silver hook

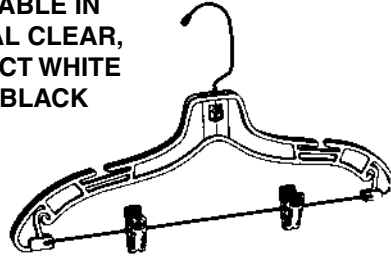

**SUIT HANGER**  
**JUNIOR 14" HEAVYWEIGHT (Sizes 7-14)**  
 Metal clips with Rubber Vinyl Inserts  
 P33 – Clear / Silver hook  
 P33B – Black / Silver hook  
 P33HI – Hi-Impact White / Silver hook

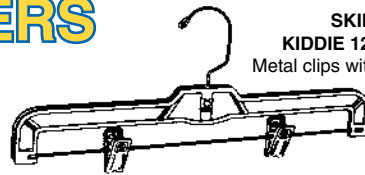

**SKIRT HANGER**  
**KIDDIE 12" HEAVYWEIGHT**  
 Metal clips with Rubber Vinyl Inserts

12," 11" & 9"  
 Wide

P82 – Clear / Silver hook  
 P82B – Black / Silver hook  
 P82HI – Hi-Impact White / Silver hook

11" Wide  
 P83 – Clear / Silver hook  
 P83B – Black / Silver hook

9" Wide  
 P84 – Clear / Silver hook  
 P84B – Black / Silver hook

**KIDDIE 12" HEAVYWEIGHT DRESS**  
 (Fits Sizes 3-6x)  
 P30 – Clear / Silver hook  
 P30B – Black / Silver hook  
 P30BB – Black / Black hook  
 P30HI – Hi-Impact White / Silver hook

**SUIT HANGER**  
**KIDDIE 12" HEAVYWEIGHT (Sizes 3-6x)**  
 Metal clips with Rubber Vinyl Inserts  
 P31 – Clear / Silver hook  
 P31B – Black / Silver hook  
 P31HI – Hi-Impact White / Silver hook

**INFANTS' 10" HEAVYWEIGHT DRESS**  
 P32 – Clear / Silver hook  
 P32HI – Hi-Impact White / Silver hook

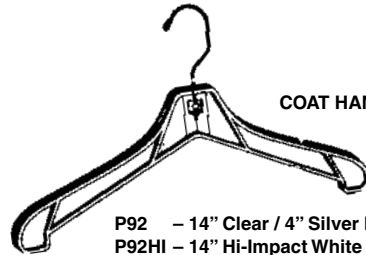

**COAT HANGERS**

P92 – 14" Clear / 4" Silver hook  
 P92HI – 14" Hi-Impact White / 4" Silver hook  
 P93 – 12" Clear / 4" Silver hook  
 P93HI – 12" Hi-Impact White / 4" Silver hook

P92LH – 14" Clear / 6" Silver hook  
 P92HILH – 14" Hi-Impact White / 6" Silver hook  
 P93LH – 12" Clear / 6" Silver hook  
 P93HILH – 12" Hi-Impact White / 6" Silver hook

## KIDS' DISPLAY HANGERS

All hangers are priced with chrome hooks. Choice of black, white, or brass hooks for additional 25¢ each. Now! For the first time, display your smaller size garments professionally and effectively. 1 1/2" thick display hangers that fill out your garments for a more effective display. Hangers are also available in Grey, Gold and Beige at 25 cents more per hanger.

We will print your logo or name on any of these at no charge.

Minimum 100 pieces for printing.

Custom colors are available.

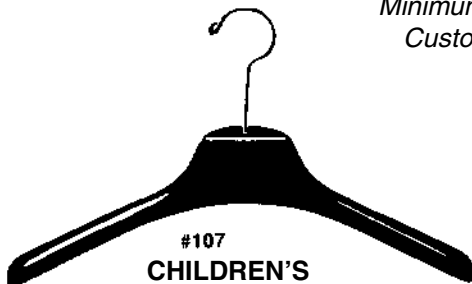

#107  
**CHILDREN'S TOP HANGER**

107 – 1 1/2" thick, 10" wide, 12" wide or 14" wide. Available in black or white. Choice of 4" or 6" hook. Choice of chrome, gold or black hooks.

**White**  
 107-10 10" (Toddler size)  
 107-12 12" (4-6x size)  
 107-14 14" (7-14 size)

**Black**  
 107-10 10" (Toddler size)  
 107-12 12" (4-6x size)  
 107-14 14" (7-14 size)

25 Hanger Minimum

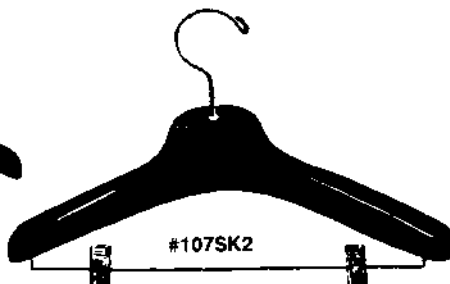

#107SK2  
**CHILDREN'S COORDINATE HANGER 2" DROP**

107SK2 – 1 1/2" thick, 10" wide, 12" wide or 14" wide. Available in black or white. Choice of 4" or 6" hook. Choice of chrome, gold, or black hooks.

107SK2-10 10" (Toddler size)  
 107SK2-12 12" (4-6x size)  
 107SK2-14 14" (7-14 size)

25 Hanger Minimum

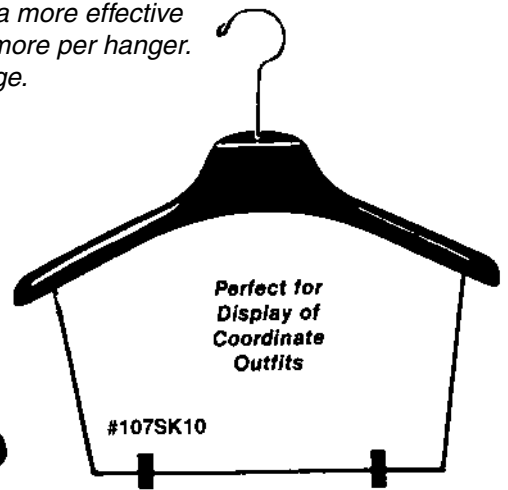

Perfect for Display of Coordinate Outfits

#107SK10  
**CHILDREN'S COORDINATE HANGER 10" DROP**

107SK10 – 1 1/2" thick, 10" wide, 12" wide or 14" wide. Available in black or white. Choice of 4" or 6" hook. Choice of chrome, gold or black hooks.

107SK10-10 10" (Toddler size)  
 107SK10-12 12" (4-6x size)  
 107SK10-14 14" (7-14 size)

25 Hanger Minimum



# UNBREAKABLE CLEAR K RESIN PLASTIC HANGERS

Higher, wider neckline adds support to collars and lapels of dresses, suits, blouses and shirts.

The neck has a hole for another hanger to attach for display of a coordinate.

K-Resin material has flexibility for longer life. Ridges on end of hanger prevent slippage. Silver hooks.

Also available in white with silver hook (484W).

- 484K – 17" (ladies)
- 479K – 19" (large sizes)
- 485K – 15" (teens)
- 498K – 12" (kids)
- 497K – 10" (infants)

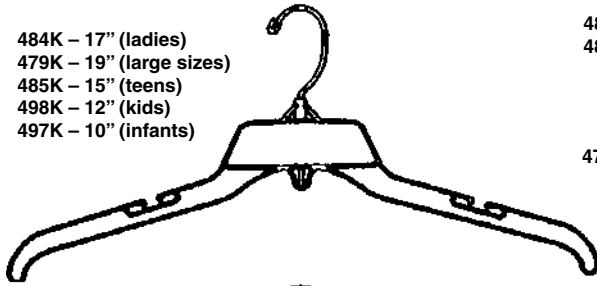

- 484K – 17" Clear, Ladies
- 484W – 17" White, Ladies

485K – 15" Clear (teens)

479K – 19" Clear (large sizes)

497K – 10" Clear (infants)  
498K – 12" Clear (kids)

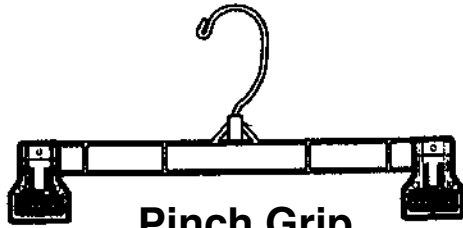

## Pinch Grip

- 6008 – 8" Clear (kids)
- 6010 – 10" Clear (teens)
- 6012 – 12" Clear (ladies)
- 6014 – 14" Clear (large sizes)

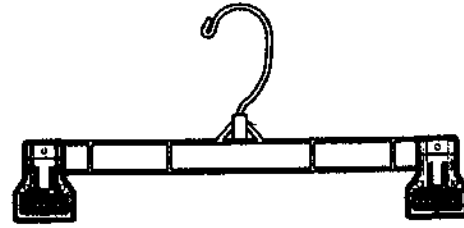

## Pinch Grip with Soft Pad

Soft pad inside clips prevents marks on delicate fabrics.

- 6210 – 10" Clear (teens)
- 6212 – 12" Clear (ladies)
- 6214 – 14" Clear (larger sizes)

# UNBREAKABLE BLACK PLASTIC HANGERS

Major department stores prefer these Vics approved hangers. Popular because of durability, price.

The neck has a hole for another hanger to attach for display of a coordinate.

Silver hooks. Black hooks are available on 484BB. These hangers are also available in white with silver hooks. Call for pricing.

- 484B – 17" Ladies
- 479B – 19" Large sizes
- 485B – 15" Teens
- 498B – 12" Kids
- 497B – 10" Infants



- 484B – 17" Ladies
- 484BB – 17" Ladies, black hook

485B – 15" Teens

497B – 10" Infants

479B – 19" (large sizes)

498B – 12" Kids



## Pinch Grip

- 6008B – 8" Black (kids)
- 6010B – 10" Black (teens)
- 6012B – 12" Black (ladies)
- 6014B – 14" Black (large sizes)



## Pinch Grip with Soft Pad

Soft pad inside clips prevents marks on delicate fabrics.

- 6212B – 12" Black (ladies)
- 6214B – 14" Black (larger sizes)

# VELVET-GRIP SLIM LINE HANGERS

Originally offered on T.V. for home usage, these velvet flocked plastic hangers are now available for your store. Strong, ultra thin, lightweight, non-slip velvet flocked hanger with chrome swivel hook. Available in black, grey, pink, or camel. 17-3/8" wide x 1/8" thick. Hang more in less space. 50 per carton.

## SUIT HANGER WITH CROSSBAR



Also available with clips.  
See below.

**SL17WBN** – Velvet-grip suit hanger with slack bar with notch.

**SL17BWBN** – Black

**SL17PWBN** – Pink

**SL17GWBN** – Grey

**SL17CWBN** – Camel

**SL17WBNPC** – Suit hanger with notch, with clips.

**SL17BWBNPC** – Black

**SL17PWBNPC** – Pink

**SL17GWBNPC** – Grey

**SL17CWBNPC** – Camel

## DRESS / BLOUSE HANGER

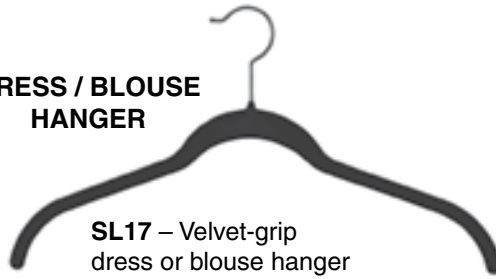

**SL17** – Velvet-grip dress or blouse hanger  
**SL17B** – Black

## LINGERIE / BLOUSE HANGER WITH NOTCHES



**SL17N** – Velvet-grip lingerie or blouse hanger with notches

**SL17NB** – Black

**SL17NP** – Pink

**SL17NG** – Grey

**SL17NC** – Camel

CLIPS COME SEPARATE AND SNAP ONTO BAR

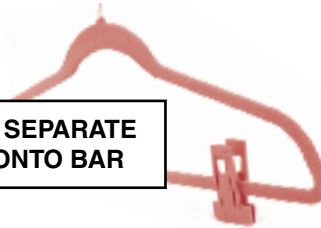

**SAVE MONEY**

## REUSED HANGERS!

**Great Condition! As good as new! Black Color.**

These styles are also available new! See page 9.

Kids 10" Wide  
Kids 12" Wide  
Teens 15" Wide  
Ladies 17" Wide  
Large Size 19" Wide



**Swivel Metal Hook**  
**UNBREAKABLE**

**484REB** – 17" Black

**485REB** – 15" Black

**498REB** – 12" Black

**497REB** – 10" Black

**479REB** – 19" Black

**UNBREAKABLE**

Swivel  
Metal Hook

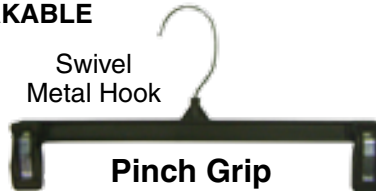

**Pinch Grip**

**6008REB** – 8" Wide Black (Kids)

**6010REB** – 10" Wide Black (Teens)

**6012REB** – 12" Wide Black (Adult)

**6014REB** – 14" Wide Black (Large size)  
(200 minimum)

## SWEATER HANGER

**584** – 17" Black, No Notches.



(200 per box)

# SLACK HANGERS

## GRIPPER HANGER / SILVER METAL HOOK

Push down metal clasp locks garment securely in place.

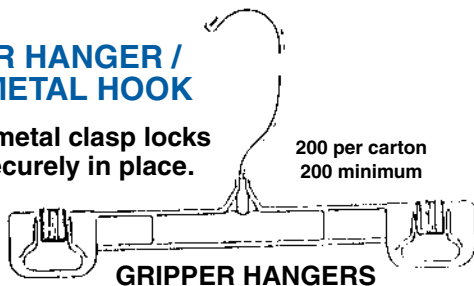

200 per carton  
200 minimum

### GRIPPER HANGERS

**KIDS – 8" Wide**  
1005HI – White  
1005B – Black

**LADIES – 10" Wide**  
105HI – White  
105B – Black  
105BB – Black/Black hook  
105N – Natural  
(Packed 200 per box)

**MENS – 12" Wide**  
1003HI – White  
1003B – Black  
1003BB – Black/Black hook  
1003N – Natural  
(Packed 200 per box)

Prevent marks on garments  
See Foam Pad Inserts, page 25.

## SWIVEL HOOK!!

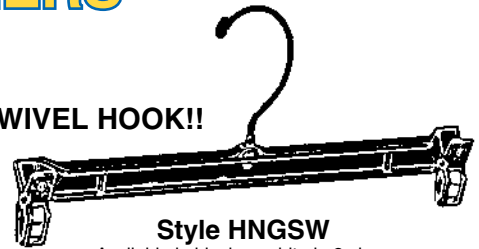

### Style HNGSW

Available in black or white in 2 sizes  
HNG9BSW – Black • HNG9WSW – White – 9-1/2" wide for ladies  
HNG11BSW – Black • HNG11WSW – White – 11-1/2" wide for men's



### Style HNG

Available in black or white. New sizer space built into neck.  
HNG9B – Black • HNG9W – White • HNG9R – Red – 9-1/2" wide for ladies  
HNG11B – Black • HNG11W – White – 11-1/2" wide for men's

## GRIPPER HANGER / PLASTIC HOOK

Push down metal clasp locks garment securely in place.

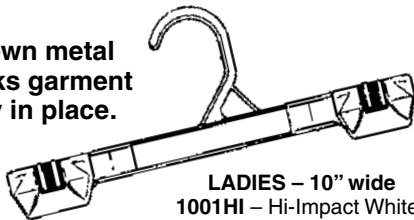

**KIDS – 8" wide**  
1004HI – Hi-Impact White  
1004B – Black

**LADIES – 10" wide**  
1001HI – Hi-Impact White  
1001B – Black  
1001N – Natural

**MENS – 12" wide**  
1002HI – Hi-Impact White  
1002B – Black  
1002N – Natural

(200 per box)

(200 per box)

## SINGLE CLIP HANGER

Holds anything from boots, scarves, ski pants, shorts, etc.

### Silver Hook, Plastic Clip

HA100W – White Clip  
HA100B – Black Clip

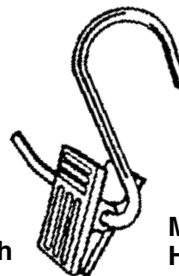

HA100SC  
Chrome Finish

### Metal Hook, Metal Clip

HA100SN – Satin Nickel Finish

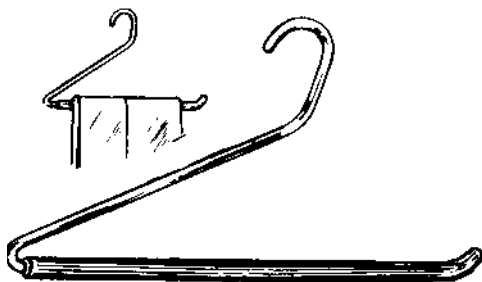

## CHROME SLACK HANGER

White vinyl serrated sleeve prevents slacks from falling, 15" long, 2 models. Heavyweight (SSLX) and Super Heavyweight (SSL).

**SSL**  
Super Heavyweight  
1/4" thick, 15" long.

**SSLX**  
Heavyweight  
1/8" thick, 15" long.



## Hercules Multi-Purpose Squeeze Clip

Black or White

HC101 – Black  
HC100 – White



## S HOOKS

Great for hanging pants and jeans thru belt loops. Silver.

Fits on 1-1/4" diameter hangrail.

S1/8 – 1/8" thick, 3-1/2" high.

S11/16 – 11/16" thick, 4" high.

# CUSTOM LOGO DESIGN & PRINTING

Personalize your hangers!! Send us your logo or we can design one for you. Self-adhesive labels, pad printing, laser engraving or metal logo plates are available. 1-4 colors printing available.

## CUSTOMIZED SELF ADHESIVE LABELS

Great for advertising your store or garments. Label sticks onto neck of hanger. Custom colors & sizes available. Call for quote. We will also apply stickers to hangers.



Style: SAL1



Style: SAL2



Style: SAL3

Labels are packed in dispenser cartons that dispense labels 1 at a time, ready for use. No charge for initial setup if camera ready art is provided. If artwork is required on a new label, cost is 75.00 per hour. Prices below include black, brown, red or blue ink. Prices for SAL1, SAL2 & SAL3 listed below.

**Stock Label**  
**(1-4 color print)**

**Metallic Silver or Gold Label**  
**(1-4 color print)**

## PAD PRINTING

One color printing on any wood or plastic hanger. One time design & plate charge approximately \$100.00. Black, white, brown, gold or red ink. Custom colors available. Minimum 500 hangers.



*For a wider selection of custom wood hangers, call and ask for free "Custom Wood Hanger Catalog."*

# WOOD HANGERS

## WIDE NOTCHED DRESS & SUIT HANGERS

*Printing Available, See Page 12*

3/8" Thick, 17" Wide

W75



**W75** – Ladies 17" Wood Dress Hanger. Notches for straps. Natural wood with lacquer finish. Silver hook. 3/8" thick.

W76



**W76** – Ladies 17" Wood Suit Hanger. Notches for straps. Natural wood with lacquer finish. Silver hook & clips. 3/8" thick.

W75BAR

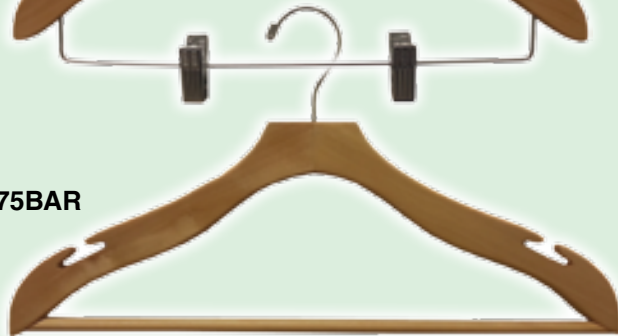

**W75BAR** – Ladies 17" Wood Suit Hanger. Notches for straps. Natural wood with lacquer finish. Silver hook. 3/8" thick.

## WOOD SKIRT & PANT HANGERS

XLP80 - Natural



XLP80

3/8" thick, 14" wide  
Natural color, Silver parts.

CLAMPER  
HANGER



1 MASTER

13/16" thick, 11-3/4" wide  
Metal mechanism locks pants in place. Cloth padding inside of clamp to protect garment. Natural color with silver parts.



# WOOD HANGERS

Natural, walnut, black or white tops and bottoms hangers, lacquer finish. Printing available, see page 12.

**200N**  
Silver Hook  
**200NSC**  
Satin Nickel Hook

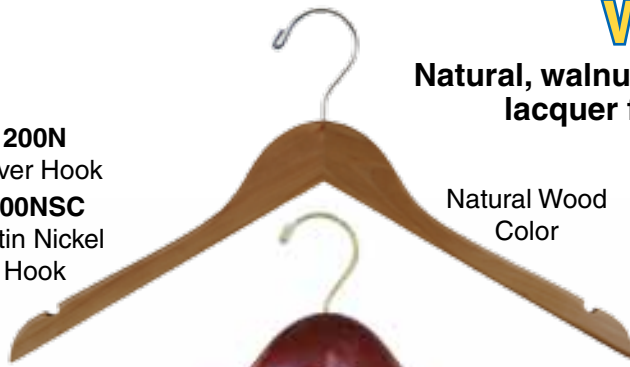

Natural Wood Color

**200 Series** – Flat shirt or jacket hanger with small notches. 17” wide, 7/16” thick. Light lacquer finish. Choice of natural, walnut, black or white color. 200BB has a matte black finish.

**200N** – Natural / Silver Hook

**200NW**  
Walnut



**200NSC** – Natural Color / Satin Nickel Hook

**200NW** – Walnut / Gold Hook

**200B** Black  
**200BB** Matte Black



**200B** – Black / Silver Hook

**200BB** – Matte Black Finish / Black Hook

**200NWH**  
White



**200NWH** – White / Silver Hook

Natural Wood Color

**XL300 Series** – Pant or skirt hangers. 14” wide, 3/8” thick, 1-1/8” high face. Light lacquer finish. Choice of natural, walnut, black or white color. XL300BB has a matte black finish.

**XL300N** – Natural / Silver Hook and Clips

**XL300NSC** – Natural / Satin Nickel Hook and Clips

**XL300W** – Walnut / Gold Hook and Clips

**XL300B** – Black / Silver Hook and Clips

**XL300BB** – Matte Black Finish / Black Hook, Bar and Clips

**XL300WH** – White / Silver Hook and Clips

**XL300N**  
Silver Parts  
**XL300NSC**  
Satin Nickel Parts



**XL300W**  
Walnut



**XL300B**  
Black  
**XL300BB**  
Matte Black



**XL300WH**  
White



# WOOD HANGERS

All Wood Hangers Have High Gloss Lacquer Finish  
Printing Available, See Page 12

**NATURAL COLOR  
OR BLACK WOODEN  
CONTOUR HANGER  
WITH CLAMP**



Made of the  
Finest Hardwood

**Style 4800** – 17" men's contoured shaped suit hanger. 1/2" thick. Curved shoulder shape. Featuring the movable dowel bar that holds trousers and clamps them separately in place. Natural color or black with lacquered finish.

**4800** – Men's 17" 1st Quality

**4800BL** – Men's 17" Black/Silver Hook

**WALNUT-STAINED  
WOODEN CONTOUR  
HANGER WITH  
CLAMP BAR**



Made of the  
Finest Hardwood

**Style 4800W** – Walnut Stained Contoured Suit Hanger. 1/2" thick. Beautiful finish. Available in 17" men's (4800W) and 19" big men's (4800W19). Printing available. Gold Hook.

**4800W** – 17" wide

**4800W19** – 19" wide

Available in  
17" Wide (Men's) and  
19" Wide (Big Men's)

**NATURAL COLOR  
OR BLACK WOODEN  
CONTOUR HANGER**



**4800N** – Natural color with lacquered finish. Contoured 17" Hanger for Menswear. 1/2" thick. Printing available.

**4800NBL** – Men's 17" black / silver hook. 1/2" thick.

**WALNUT-STAINED  
WOODEN  
CONTOUR HANGER**



**Style 4800NW** – Walnut stained contoured 17" hanger for men's and 19" wide for big men's (4800NW19). 1/2" thick. Printing available. Gold Hook.

**4800NW** – 17" wide

**4800NW19** – 19" wide

Available in  
17" Wide (Men's) and  
19" Wide (Big Men's)

**NATURAL COLOR  
WOODEN  
CONTOUR HANGER  
WITH CLIPS**



**Style 4800V/C** – Natural Color, 17" Hanger with Clips. 1/2" thick. Silver Parts. Lacquer Finish.

**WALNUT STAINED  
CONTOUR HANGER  
WITH CLIPS**



**Style 4800WV/C** – Walnut Stained, 17" Hanger with Clips. 1/2" thick. Gold Parts. Lacquer Finish.



**75** – Natural Wood Color Ladies 16" Flat Wood Hanger. 7/16" Thick. Gold or Silver Hook. Printing available.



**75SK** – Natural Wood Color Ladies 16" Suit Hanger. Flat 7/16" Thick. Gold or Silver Parts. Printing Available.

# SPECIALTY WOOD HANGERS

- Finest Hardwood • Natural Wood Color With Silver Parts • Walnut With Gold Parts
- Lacquer Finish • Custom Colors • Printing Available, See Page 12

12M – Natural  
12MW – Walnut

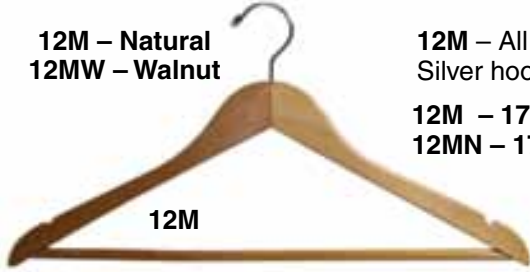

12M – All purpose flat suit hanger. 17" wide, 7/16" thick. Silver hook. Natural or Walnut color with lacquer finish.

12M – 17" Natural Suit without Notches      12MW – 17" Walnut Suit with gold hook  
12MN – 17" Natural Suit with Notches

204N – Natural  
204W – Walnut



204 – Flat suit or pant suit hanger with small notch. 17" wide, 7/16" thick. Natural or Walnut color with lacquer finish.

204N – 17" Natural Color / Silver Hook  
204W – 17" Walnut Color / Gold Hook



W70SER  
Serrated Rubber Inserts

W70SER – Ladies 17" wood dress hanger with small notch. Inlaid serrated rubber between notch and end of hanger keeps garment from sliding. 3/8" thick.

W70SER – 17" Dress with Rubber Insert

## CHILDREN'S WOOD HANGERS

Natural Wood With Lacquer Finish • 3/8" Thick  
Available with silver or satin nickel hooks and clips.

W32SER  
Serrated Rubber Inserts



W32SER – Kids 10-1/4" wide with inlaid serrated rubber at ends of hanger. With notches. Silver hook. Also available in 17" (W70SER)



W82 – 10" wide kids bottom hanger. Silver hook and clips.

200N14 – Juniors 14" wide with notches. Silver color hook.



200NSC14 – Juniors 14" wide with notches. Satin Nickel color hook.

XL300N12 – Kids 12" pant hanger. 3/8" thick, 1-1/8" high face, 12" wide. Silver color hook and clips.



XL300NSC12 – Kids 12" pant hanger. 3/8" thick, 1-1/8" high face, 12" wide. Satin Nickel color hook and clips.

# ECONOMY ALL PLASTIC GIVEAWAY HANGERS

SAVE IMPORTANT DOLLARS BY USING THESE INEXPENSIVE HANGERS.  
HANGERS MADE OF HI-IMPACT WHITE PLASTIC.

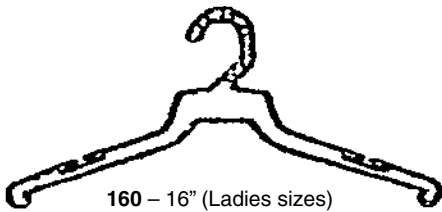

160 – 16" (Ladies sizes)

145 – 14" (7-14 Sizes) (Teens)

125 – 12" (3-6x Sizes) (Kids)

110 – 10" (Infants Sizes)

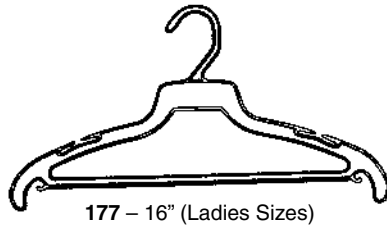

177 – 16" (Ladies Sizes)

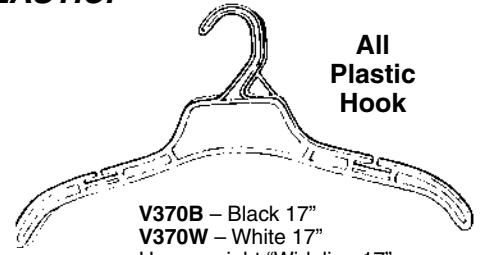

All  
Plastic  
Hook

V370B – Black 17"  
V370W – White 17"  
Heavyweight "Wideline 17"

(200 per box) Minimum: 200 pcs.



INTIMATE APPAREL HANGER  
10" Wide  
KM1 – Clear

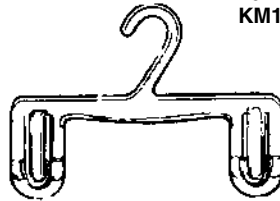

S11 – 11" Skirt or Pant Hanger  
Garment Held Securely by Fingers

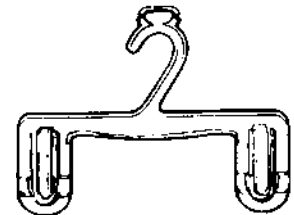

DS11 – Drop Attachment 11" Wide  
Use as S11 or fit over the hook of any  
hanger to combine two piece outfits

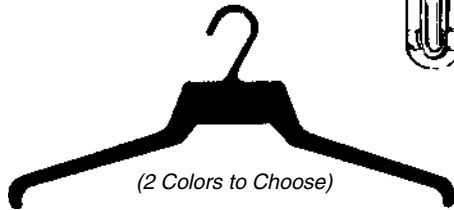

(2 Colors to Choose)

185 – Men's Shirt Hanger  
Full 18" to fill out shoulders  
185W – Hi-impact White Styrene  
185B – Jet Black Color

S8 – 8" Skirt or Pant Hanger  
For Smaller Size Garments

DS8 – Drop Attachment 8" Wide

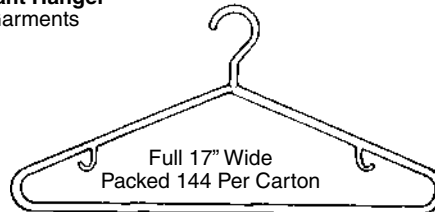

COLORFUL TUBULAR  
DISPLAY HANGERS

BDH17W – White 17"  
BDH17B – Black 17"

144 per carton

Also in 10 other colors!!  
Call for selection!

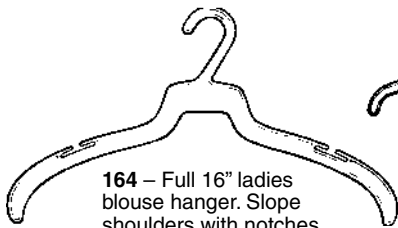

164 – Full 16" ladies  
blouse hanger. Slope  
shoulders with notches.

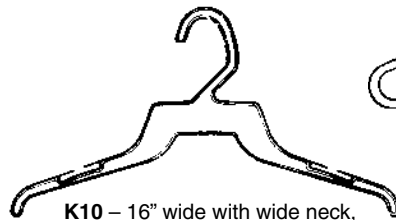

K10 – 16" wide with wide neck,  
notches. Heavy Weight.

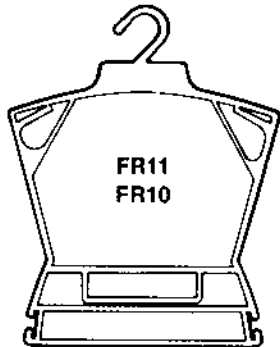

FR11  
FR10

## FRAME HANGERS

FR11 – Children's sizes 2-4,  
3-6x, 11 1/2" wide, 12 1/2"  
long. For 2 piece sets, halters,  
tubes. (200 per box.)

FR10 – Infants sizes 1-3x,  
9 1/2" wide, 10" long.

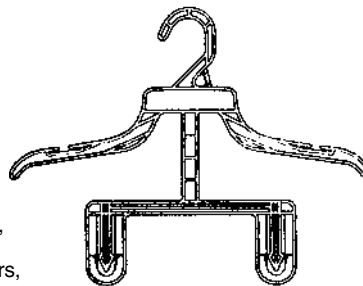

## CO-ORDINATE SET HANGERS

799-12" (3-6x Kids Sizes)  
899-14" (7-14 Juniors)

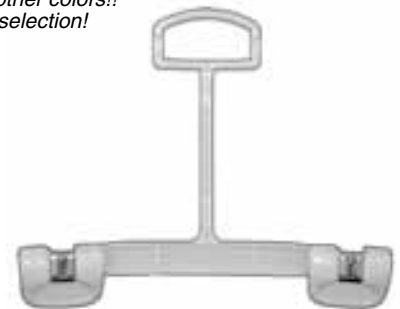

## DROP ATTACHMENT

Fits over hook of any hanger for  
coordinate display. 4" drop.

1104 – 8" wide white  
1100 – 10" wide white  
1102 – 12" wide white

Also available in black & natural.

# BLACK PLASTIC MEN'S & WOMEN'S HANGERS

• Silver Color Hook • Printing Available • Custom Stickers Available & Applied • See Page 12

## CONCAVE SHAPE STYLE

**BLAZER15** – 15" Wide – Ladies

**BLAZER17** – 17" Wide – Mens

**BLAZER19** – 19" Wide – Big Mens



## BLAZER CONCAVE COAT HANGER

15" 17" or 19" wide, 1/2" thick.  
For coats, jackets, shirts  
and blazers.

**BLAZER17** – 17" Wide (men's)

**BLAZER15** – 15" Wide (women's)

**BLAZER19** – 19" Wide (big men's)

## HERCULES CONCAVE SUIT HANGERS

15", 17" or 19" wide, 1/2" thick suit hangers.  
Pants drape over bar securely.

**HERC19** – 19" Wide

**HERC19F** – 19" Wide  
(Non-Slip Bar)

**HERC17** – 17" Wide

**HERC15** – 15" Wide

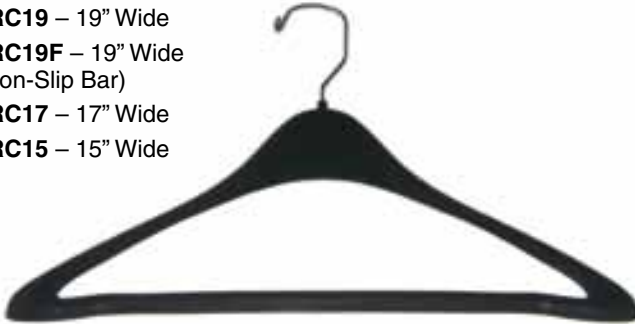

**HERC17** – Men's 17" Wide (Sizes 38-46)

**HERC19** – Big Men's 19" Wide (Sizes 48-60)

**HERC19F** – Big Men's 19" Wide with Flocked

**HERC15** – Boy's 15" Wide

## BROAD SHOULDER CONCAVE SUIT HANGER

17", 19" or 21" wide, 1" thick at ends.  
Full body presentation.

### Broad Shoulder Suit

**610** – 17" Wide

**611** – 19" Wide

**612** – 21" Wide



**610** – 17" Men's (Sizes 38-46)

**611** – 19" Wide Big Men's (Sizes 48-60)

**612** – 21" Wide Extra Big Men's Sizes

### Concave Suit Hanger

**4800B** – 17" Wide



## CONCAVE SUIT HANGER / PANTS CLAMP

17" wide, 1/2" thick with movable wood bar  
that clamps trousers in place.

**4800B** – 17" Wide Men's Suit



# CONCAVE EXTRA BROAD SHOULDER HANGERS



**CONCAVE COAT HANGER**  
417 – 17" Wide

419 – 19" Wide

415 – 15" Wide

*1" thick hanger that flares out to 1-1/2" at ends of hanger. Plastic, black color, silver hook. 50 per box. Prices are per 100. Printing available, see page 12.*



**CONCAVE SUIT HANGER**

Has a movable wood bar that clamps trouser in place.

**417W/B** – 17" Wide with Clamp Bar

**419W/B** – 19" Wide with Clamp Bar

## FLAT PLASTIC OUTERWEAR HANGERS

Perfect for jackets, leathers, shirts, sweaters. 3/8" thick, silver hook, black color. 100 per box. Printing available, see page 12.

**JAC16** – 16" Wide  
**BIGJAC** – 18" Wide



**JAC16** – 16" Wide (women's)

**BIGJAC** – 18" Wide (men's)

**P90B**  
**P90BB**



**P90B** – 17" Wide Black / Silver Hook  
**P90BB** – 17" Wide Black / Black Hook

**200NPB** – 17" Wide



**FLAT SHIRT OR TOP HANGER**  
**200NPB** – 17" wide with notch.

**XL300PB**



**FLAT SKIRT OR PANT HANGER**  
14" wide, oversized pant clips, silver hook and clips.  
**XL300PB** – 14" Wide

# STEEL CHROME PLATED HANGERS

Prices Per 100



**BLOUSE & DRESS HANGER**

213 – Beautiful chrome plated. Takes up minimum amount of space. Unbreakable. **Will last a lifetime.** Prices per 100.

- 21312 – 12" Kids
- 21314 – 14" Teens
- 21316 – 16" Ladies
- 21318 – 18" Men's
- 21319 – 19" Men's



**SKIRT HANGER**

245 – Chrome plated skirt or pants hanger. Clips adjust for any size pants or skirt. 12" long. Prices per 100.

**COMBINATION HANGER WITH VINYL CUSHION CLIPS**

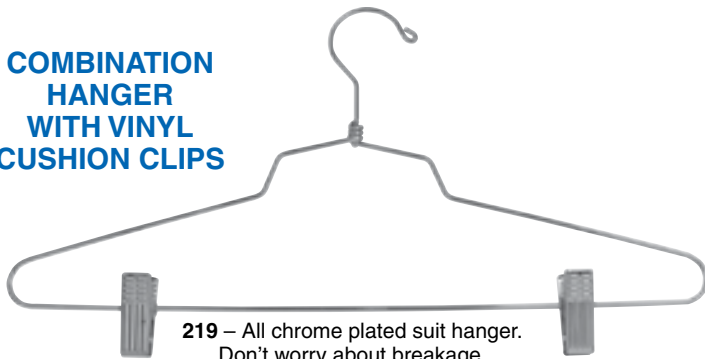

219 – All chrome plated suit hanger. Don't worry about breakage. It **can't** happen. Prices per 100.

21916 – 16" Ladies



**BIKINI BATHING SUIT HANGER**

27 – Great for display of two-piece bathing suits, pants, etc. Prices per 100.

**NON-SLIP HANGERS**



PC16WSW – White 16" swivel hook  
PC16BSW – Black 16" swivel hook



TSB1070 – Extra heavy duty 4MM diameter thick chrome coat hanger, 17" wide.



**LINGERIE HANGER**

312 – Great for strapped garments such as lingerie or swimwear. Prices per 100.

**CHROME BEDSPREAD / DRAPERY HANGER**



SBD/22 – 22" wide, rubber grips on bars prevent slipping.

**DRAPERY AND BEDSPREAD HANGERS**



SSL193X – 19" durable chrome plated metal bedspread/drapery hanger with a non-slip rubber serrated bar. 8.0MM thick. Perfect for heavy fold over items. 5" opening. 12 per box.

# SALESMAN'S SUPPLIES

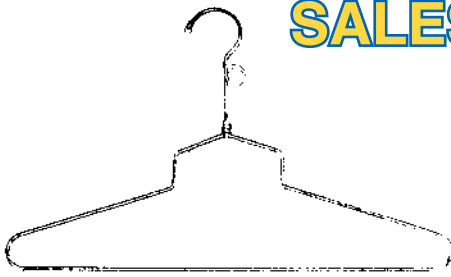

**BLOUSE & DRESS HANGER**

- 213 16LH – 16" Ladies
- 213 14LH – 14" Teens
- 213 12LH – 12" Kids
- 213 18LH – 18" Mens
- 213 19LH – 19" Mens

*Loops in neck  
for easy handling  
of garments*

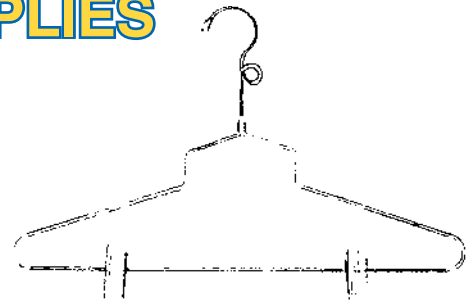

**COMBINATION HANGER WITH  
VINYL CUSHION CLIPS**

219 16LH – 16" Ladies

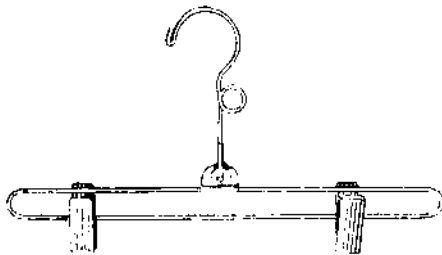

**SKIRT OR SLACK HANGER**  
245LH – 12" Long

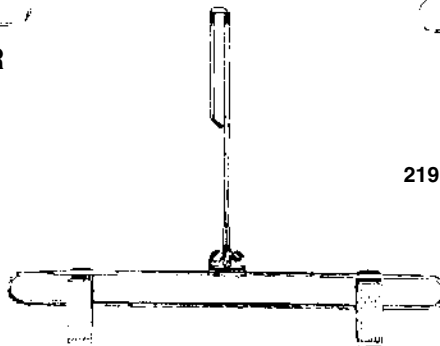

**DROP ATTACHMENT**  
DSA9 – 9" Drop

DSA16 – 16" Drop

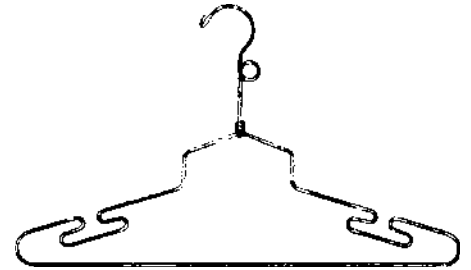

**LINGERIE HANGER**  
312LH – 16" Lingerie with notches  
for strapped garments.



**DIAPER PIN ROD**

Insert through loops of hangers to  
hold garments together.

DP14

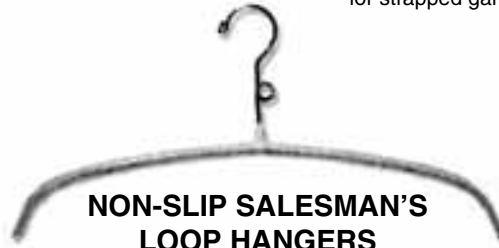

**NON-SLIP SALESMAN'S  
LOOP HANGERS**

PC17WLH – White 17" swivel hook

## SALESMAN'S FOLDING TRIPOD RACK

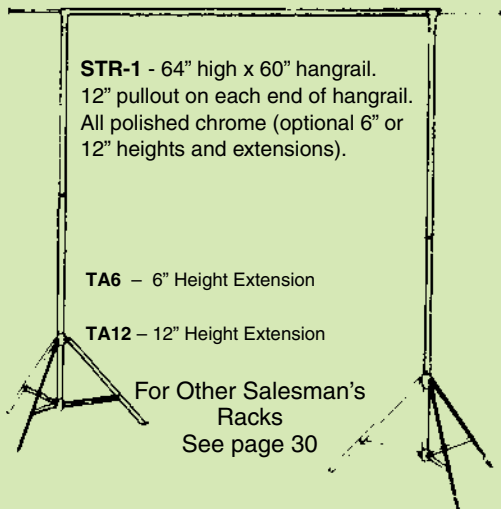

**STR-1** – 64" high x 60" hangrail.  
12" pullout on each end of hangrail.  
All polished chrome (optional 6" or  
12" heights and extensions).

**TA6** – 6" Height Extension

**TA12** – 12" Height Extension

For Other Salesman's  
Racks  
See page 30

## TRANSPORTATION GARMENT BAGS

Made of Water Repellent Duck

Complete size range to accommodate all  
garments. Worth their weight in gold. So  
ever handy. Just hang your garments on  
a rack. Slip garment bag around them,  
and away you go! At your destination,  
hang it up, unzip and you're ready for action.  
Designed for rugged use to last a  
lifetime.

**GRIPTIGHT 15" BAR**  
Hangerlock Bar  
Each bag holds 1-25 garments

- HL38—38" long—Blouses
- HL42—42" long—Jackets
- HL48—48" long—Dresses
- HL57—57" long—Coats
- HL66—66" long—Rainwear
- HL72—72" long—Gowns



# STOCK ROOM WIRE HANGERS

ECONOMICAL WIRE HANGERS – SAVE YOUR SPACE AND MONEY.  
UNBREAKABLE!! HIGH GLOSS LACQUER GOLDTONE FINISH!!  
GREAT FOR STORAGE OF SEASONAL MERCHANDISE.



DRESS  
OR  
SUIT HANGER

DRESS HANGER

14G-16 – 16" (Ladies Lightweight)

SUIT HANGER

13G-16 – 16" (Ladies Heavyweight)

13G-13 – 13" (Junior Sizes 3-14)

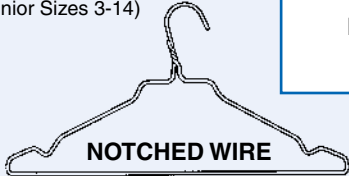

NOTCHED WIRE

13GN – Notched for  
Ladies' Strapped Garments

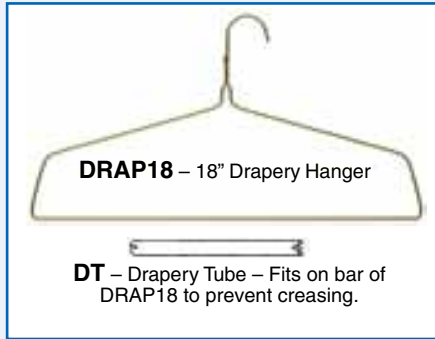

DRAP18 – 18" Drapery Hanger

DT – Drapery Tube – Fits on bar of  
DRAP18 to prevent creasing.

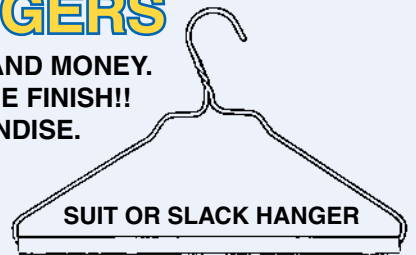

SUIT OR SLACK HANGER

Round Cardboard Dowel Protects  
Trousers From Creasing

MENS & LADIES

165-16 Strut – 16" Wide

18 Strut – 18" Wide

165-

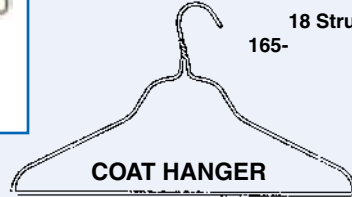

COAT HANGER

11G-16 – 16" Ladies Super Heavyweight

11G-18 – 18" Big Mens Super Heavyweight

## IMPRINTED POLY BAGS ON ROLLS

Now you can buy imprinted poly bags at prices that the chain stores pay... and all you have to do is by 50 rolls of mixed sizes!! Derive the powerful advertising effect of 1, 2, or 3 color printing on clear or colored heavyweight 1 mil poly bags. Your imprint repeats every 18 inches!! 1st time plate charge \$75—\$100 per imprint color. Prices below include one color imprint. Imprint colors: black, blue, red, green, gold or white. For 2-color imprint add \$4.50 to prices. For 3-color imprint add \$9.00 to prices listed below. Allow 2 weeks for delivery.

### CLEAR & COLORED BAGS

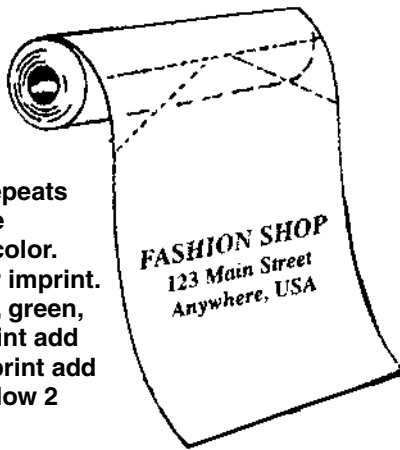

### CLEAR POLY BAGS

**See Through Clear** – Superweight .001 mil, 21" wide, 4" gusset. Price includes 1 color imprinting. You can combine sizes to achieve 36 roll minimum.

Style	Length	Ideal For	Bags on Roll
130P	30"	Blouses	420
136P	36"	Suits, Blouses	350
142P	42"	Suits, Jackets	300
154P	54"	Dresses, Coats	233
160P	60"	Coats	210
172P	72"	Bridals, Formals	175

### COLORED POLY BAGS

**Opaque Colored** – Superweight .001 mil, 21" wide, 4" gusset. Choice of black, white, blue or red colored poly. Prices include color imprinting. You can combine sizes to achieve 50 roll minimum.

Style	Length	Ideal For	Bags on Roll
130C	30"	Blouses	420
136C	36"	Suits, Blouses	350
142C	42"	Suits, Jackets	300
154C	54"	Dresses, Coats	233
160C	60"	Coats	210
172C	72"	Bridals, Formals	175

### SMALL LOT IMPRINTED POLY ON ROLLS

Buy as few as 3,000 bags of a size. Combine sizes for quantity pricing. Superweight .01 mil, 21" wide, 3" side gussets. Price includes 1 color printing on 1 side repeating every 18 inches. 2 color printing on 1 side or 2 sides (call for price). 1 color printing on 2 sides (call for price). 1 time plate charge approximately \$100.

**Poly Colors:** Black, Ivory, Gray, Buff, Orange, Red, Dk. Blue, Hot Pink, Baby Pink, Peach, Dusty Rose, Dk. Green, Teal.

**Ink Colors:** All standard colors.

	Length	Ideal Use	Bags per roll
M130	30"	Blouses	600
M136	36"	Suits	500
M138	38"	Jackets, Suits	474
M140	40"	Jackets, Suits	450
M148	48"	Dresses	375
M154	54"	Coats	333
M160	60"	Coats	300
M172	72"	Bridals, Formals	250

# UNPRINTED POLY BAGS ON ROLLS

All unprinted poly bags are in stock for same day delivery

## CRYSTAL CLEAR TRANSPARENT GARMENT BAGS

You may never use costly wrapping again. Why pack in a box? Save TIME, LABOR AND MONEY. Snap off a bag – like the dry cleaners do!! Great for storage of lay-aways and seasonal merchandise. These transparent bags are made of tubular polyethylene and feature heat-sealed shaped shoulders with a hanger opening. In stock for immediate delivery. Available in 2 different weights – 1/2 mil thickness (typical of dry cleaner bags) and 1 mil thickness (2 times the weight of your typical dry cleaner bags).

### MEDIUM WEIGHT (1/2 Mil) - 20" Wide, 3" Gusset

Style	Length	Ideal For:	Quantity on Roll
#530	30"	Blouses	1,200
#536	36"	Suits, Jackets	1,000
#548	48"	Jackets, Dresses	750
#554	54"	Dresses, Coats	667
#560	60"	Coats	600
#572	72"	Bridals, Formals	500

### SUPER WEIGHT (1 Mil) - 21" Wide, 4" Gusset

Style	Length	Ideal For:	Quantity on Roll
#130	30"	Slacks, Shirts, Skirts	420
#136	36"	Suits, Jackets	350
#142	42"	Suits, Jackets	300
#148	48"	Dresses	262
#154	54"	Dresses, Coats	233
#161	60"	Coats	210
#166	66"	Bridesmaids, Formals	190
#172	72"	Bridals, Formals	175

### SUPER WEIGHT (1 Mil) EXTRA WIDE BRIDAL BAGS 24" Wide, 8" Gusset

Style	Length	Ideal For:	Quantity on Roll
#872	72"	Bridals	250

## JUMBO ROLLS

HAVE TWICE AS MANY BAGS  
AS ROLLS SOLD BY  
OTHER DISPLAY HOUSES

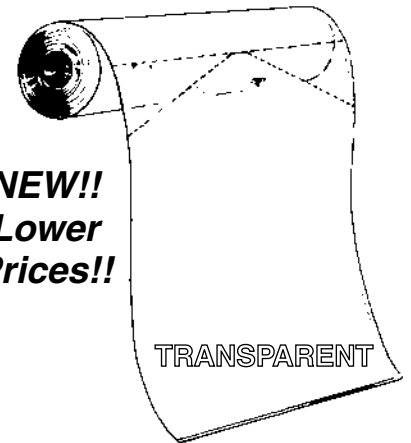

**NEW!!**  
**Lower**  
**Prices!!**

THESE ROLLS HAVE TWICE AS MANY BAGS AS YOUR AVERAGE ROLL

Snow white color bags prevent thieves from seeing the goods as they leave your store. Commonly used for your customer's protection on carry outs. In stock in 3 popular sizes.

## WHITE OPAQUE GARMENT BAGS ON ROLLS

### SUPER WEIGHT (1 Mil) - 21" Wide, 4" Gusset

Style	Length	Ideal For:	Quantity on Roll
136W	36"	Suits, Jackets	400
154W	54"	Dresses, Coats	267
172W	72"	Bridals, Formals	200

## COLORED POLY BAGS ON ROLLS

### SUPER WEIGHT (1 Mil) - 21" Wide, 3" Gusset

Black, Red, Ivory or Grey Poly Bags on rolls in stock, ready to ship for immediate delivery.

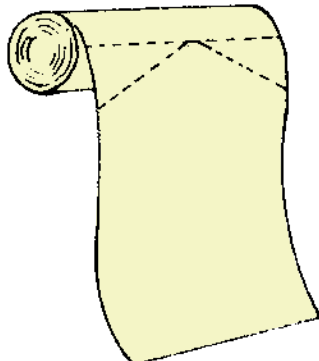

Style	Color	Length	Ideal For:	Quantity on Roll
136B	Black	36"	Suits, Jackets	500
136R	Red	36"	Suits, Jackets	500
136IV	Ivory	36"	Suits, Jackets	500
136GR	Grey	36"	Suits, Jackets	500
154B	Black	54"	Dresses, Coats	333
154R	Red	54"	Dresses, Coats	333
154IV	Ivory	54"	Dresses, Coats	333
154GR	Grey	54"	Dresses, Coats	333
172B	Black	72"	Bridals, Formals	250
172R	Red	72"	Bridals, Formals	250
172IV	Ivory	72"	Bridals, Formals	250
172GR	Grey	72"	Bridals, Formals	250

Call to order other colors:  
Orange, Yellow, Silver, Dk. Green,  
Buff, Dk. Blue, Teal, Baby Pink,  
Hot Pink, Gold, Peach.

ALL POLY BAGS IN STOCK FOR IMMEDIATE DELIVERY!!



# SHOULDER COVERS

**Lower Prices**

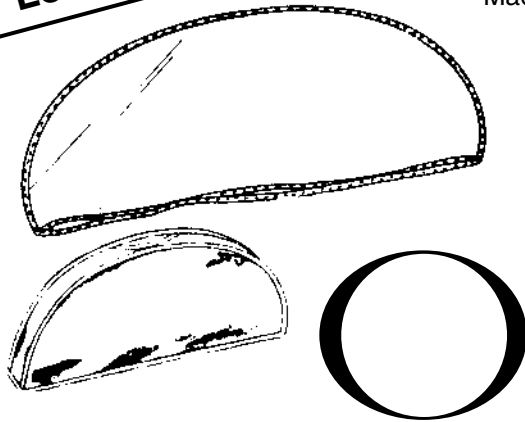

Low cost covers to keep your clothing fresh, neat & clean. Made of crystal clear plastic.

2 Gauge are sewn at the edges for strength & durability.  
5 Gauge Covers are available sewn or sealed at edges.

## HEAVYWEIGHT 2 GAUGE (No Gussets)

Style	Size	Description
V-4L	8x21	Ladies' Wear
V-6	9x24	Men's and Ladies' Coats

## HEAVYWEIGHT 2 GAUGE WITH GUSSETS

Style	Size	Description
V-4X	8x21x2	Ladies' Suits

**COVER OUTDOOR OR STORAGE RACKS!**

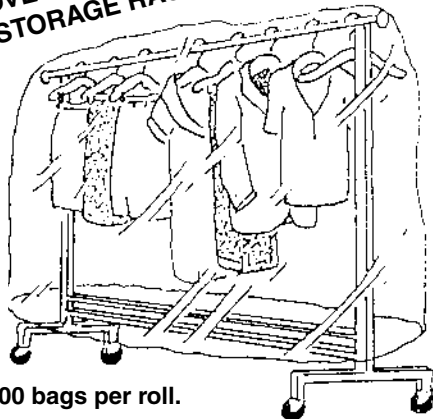

100 bags per roll.

# RACK COVERS

Clear See-Thru Poly Rack Covers. Heavy 1 mil. Prevent dusty clothing. Covers any garment rack with clothing on it. 58" high x 100" long. Style RC100. 100 bags per roll.

**RC100 – RACK COVER**

# POLYETHYLENE SHOULDER COVERS



Economy 1 Mil Cover  
Transparent Seams  
Are Heat Sealed

**P-4L – 13" x 21" Cover**

# POLY BAG DISPENSERS

All Chrome Parts! A Necessity For Every Store!



## 3 ROLL DISPENSER

- Adjustable Jack
- 1" Sq. Tubing Construction
- Easy Feed Rollers
- Minimal Space Needed
- Shipped UPS

**STYLE CHB2**

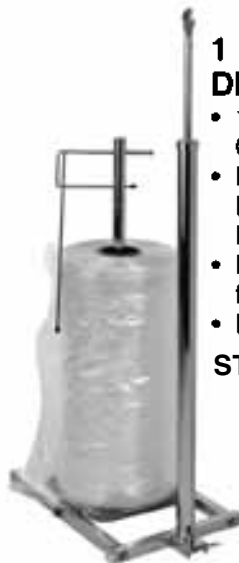

## 1 ROLL DISPENSER

- 1" Sq. Tubing Construction
- Holds 1 Roll on Ball Bearing Platform for Easy Turning
- Bagging Jack Adjusts from 39" to 68"
- Base is 13" x 18"

**STYLE K31**

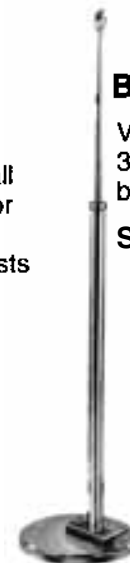

## BAGGING JACK

Vertical Jack adjusts from 39" to 68". Heavy weight base is 12" diameter.

**STYLE K32**

# NON-SLIP HANGER ATTACHMENTS

Prevent garments from falling off hangers. Keeps your merchandise neat and orderly for perfect display.

## FOAM PAD HANGER COVER

For 17" Hangers  
M42 – Charcoal Gray  
M43 – White

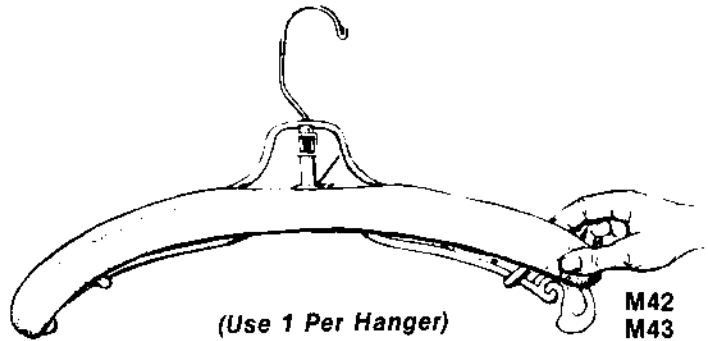

## CRYSTAL CLEAR VINYL ATTACHMENTS

M17 – Non-Slip Attachment  
(200 per Bag – Minimum 200 Pieces)

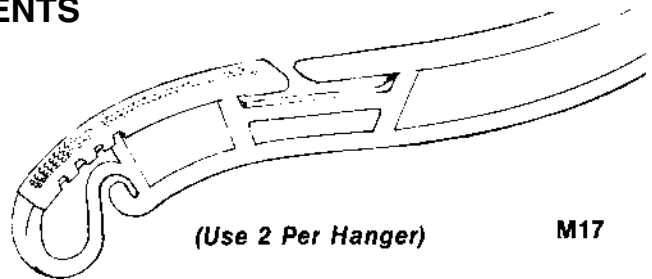

## STICK-ON FOAM PADS

4" Long x 3/8" Wide  
Same material as Foam-Pad Covers  
but has Self-Adhesive Backing. 1,600 per roll.

PAD42 – Gray

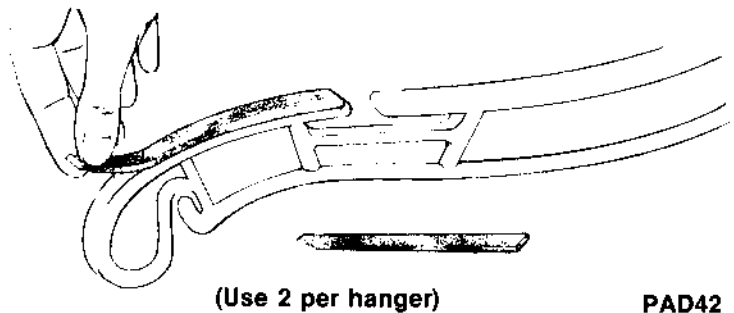

## NON-SLIP RUBBER HANGER ATTACHMENTS

"Sling-Shot Rubber Attachments"



Rubber Attachments to fit on ends of  
dress hangers. Available in Natural White,  
Black or Clear. Minimum 200.

"Sling-Shot"  
Rubber Attachments

Use 2 per hanger

SS3B – Black  
SS3C – Clear

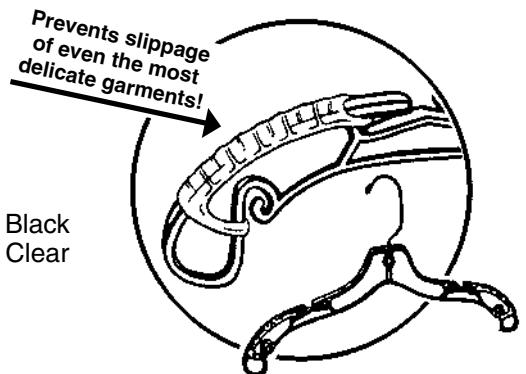

## PIGGY-BACK CONNECTORS

**DSA – 2" Drop**  
Display coordinates.  
Natural color.

DSA  
2"  
Height

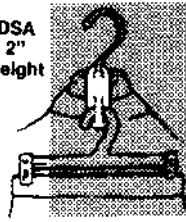

Example of  
DSA in use.

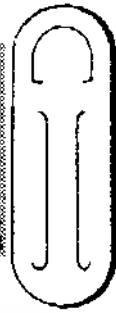

**DSA3 –**  
16" Clear  
Connector  
with 11 holes.  
You can hang  
coordinate at  
any height.  
Clear.



DSA1

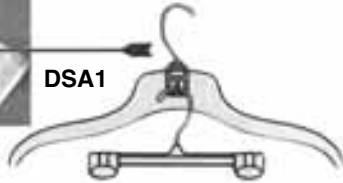

DSA1 – 1" Drop, Natural Color

## PAD PROTECTORS

**FOAM GRIPPER PADS**

Use 2  
Per Hanger

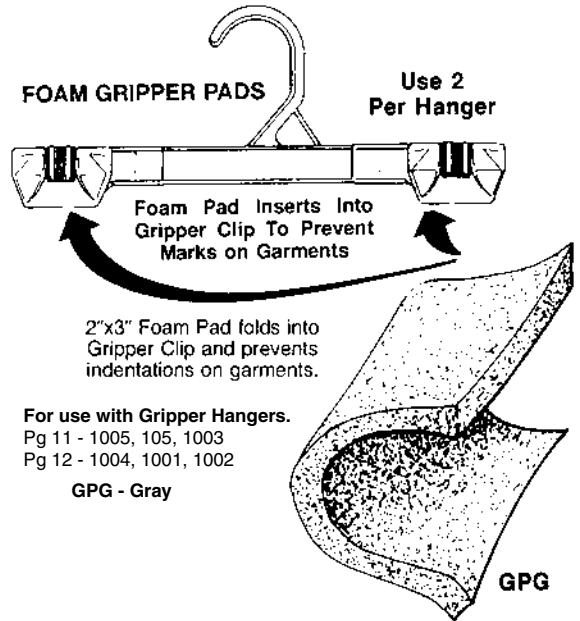

Foam Pad Inserts Into  
Gripper Clip To Prevent  
Marks on Garments

2"x3" Foam Pad folds into  
Gripper Clip and prevents  
indentations on garments.

For use with Gripper Hangers.  
Pg 11 - 1005, 105, 1003  
Pg 12 - 1004, 1001, 1002

GPG - Gray

See Gripper & Pinch Grip Hangers Pages 9-11.

## VINYL ZIPPERED COVERS

Lifetime advertising. Heavy-duty 3 gauge taffeta finish in 40" and 54" lengths. Full-length zipper, reinforced hanger opening and a crystal clear "see thru" window. Available in Taffeta or Alligator Finish.

### FREE IMPRINTING & PLATE

For block letters (3 lines maximum) or special logos there is a one time design charge of \$60. For imprinted bags allow 3 weeks for delivery. Blank bags are in stock for immediate delivery. No design charge on orders of 500 bags or more. Maximum printing area: 6" wide x 3" high.

### TAFFETA FINISH (3 gauge)

**VZ40 – Suit or Jacket Size – 24" Wide x 40" Long**

VZ40B/G	Black/Gold Trim	VZ40M	Maroon/Maroon Trim
VZ40B/B	Black/Black Trim	VZ40G	Gold/Gold Trim (add \$25.00 per 100)
VZ40S	Silver/Silver Trim	VZ40Y	Yellow/Yellow Trim
VZ40T	Beige/Beige Trim	VZ40N	Brown/Brown Trim
VZ40G/G	Gray/Gray Trim	VZ40W	White/White Trim
VZ40R	Red/Red Trim	VZ40L	Blue/Blue Trim
VZ40/C	Clear		

**BLANK BLACK BAGS IN STOCK  
FOR IMMEDIATE DELIVERY  
VZ40B/B**

**VZ54 – COAT OR DRESS SIZE – 24" Wide x 54" Long**

VZ54B/G	Black/Gold Trim	VZ54B/B	Black/Black Trim
VZ54C	Clear (Add \$15.00 per 100)	VZ54N	Brown/Brown Trim
VZ54S	Silver/Silver Trim	VZ54T	Beige/Beige Trim
		VZ54R	Red/Red Trim

**BLANK BLACK BAGS IN STOCK  
VZ54B/B**

### ALLIGATOR FINISH (5 gauge)

**AZ40 – Suit or Jacket Size –  
24" Wide x 40" Long**

AZ40B/B Black/Black Trim

**AZ54 – Alligator Finish Coat –  
24" Wide x 54" Long**

AZ54B/B Black/Black Trim

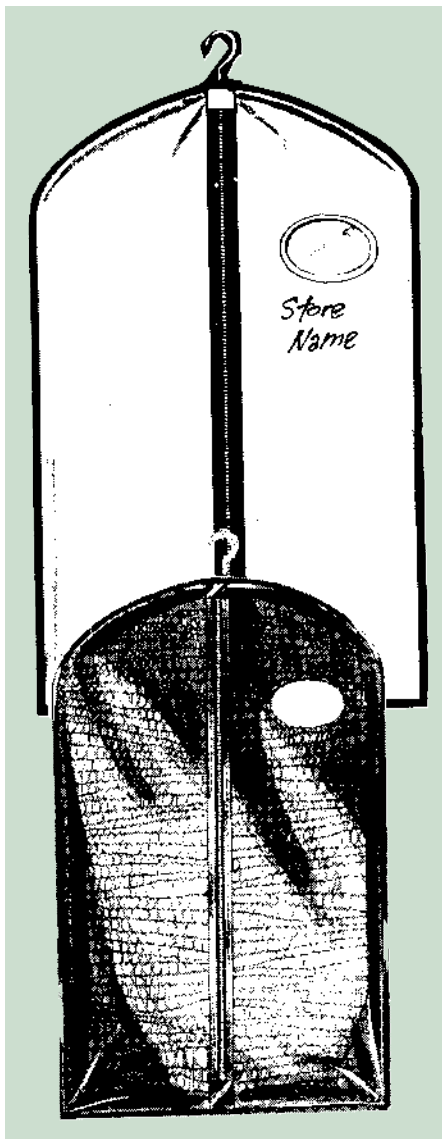

Please Allow 2 Weeks for Printed Bag Orders  
Unprinted Black Bags Are in Stock!

# BRIDAL GOWN COVERS

AVAILABLE IN CRYSTAL-CLEAR VINYL (BB72), WHITE VINYL (W72), PINK VINYL (PK72)  
PLASTIC ZIPPERED COVERS TO KEEP YOUR MERCHANDISE FREE FROM DIRT, DUST AND DAMAGE



## FREE! Your Store Name Imprinted In Gold

Cash in on this great advertising idea!  
These covers will always stay with your  
creation giving you years of advertising.

### Free Imprinting

For special logos or block letters, there is a one time  
plate charge of \$55.00 (3 line maximum). All plates  
are filed for future orders.

**Printing colors:** black, beige, yellow, grey, gold,  
silver, orange, red, hot pink, navy blue, burgundy  
brown, green

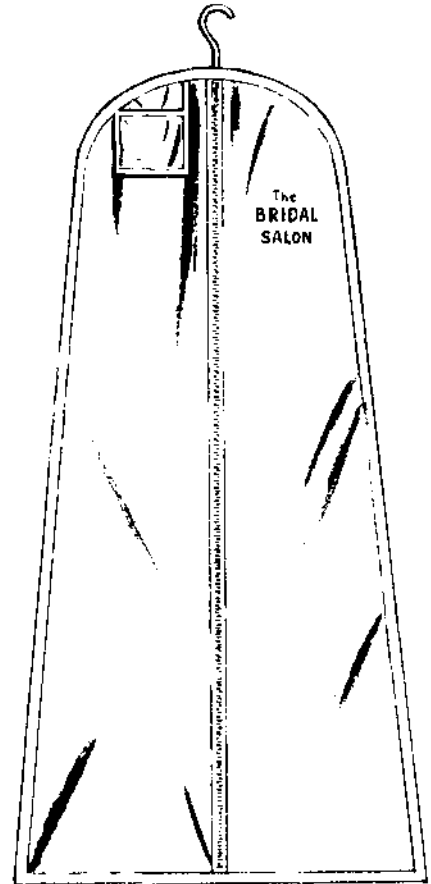

### CRYSTAL CLEAR BRIDAL BAGS

Clear Bridal Covers with 12" gussets. Featuring bell bottom style, full  
length zipper, heavy 4 gauge vinyl and reinforced hanger opening.

**8 Dozen Minimum for Printing**  
**Blank Bags In Stock for Immediate Delivery**

BB72	72" Long
BB66	66" Long
BB60	60" Long
BB54	54" Long

PRICES ARE PER DOZEN

### OPAQUE BRIDAL BAGS

**W72 – White**  
**PK72 – Pink**  
**BK72 – Black**

Heavy Duty Vinyl Bridal Bags  
24" wide at breast level, 36" wide bottom, 72" long  
3 Gauge – Full Length Zipper  
Reinforced Hanger Opening  
8 Dozen Minimum for Printing  
Black Bags in Stock for Immediate Delivery

**W72 – White**  
**PK72 – Pink**  
**BK72 – Black**

### OVERLAP COVERS

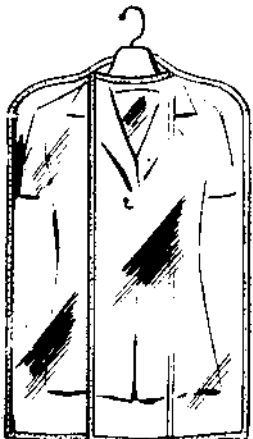

Heavy 2 gauge vinyl. OC36 and OC54  
are open bottom. OC72 has a closed  
bottom. 120 per box.

**OC36 – 24 x 36 Suit**  
**OC54 – 24 x 54 Coat**  
**OC72 – 24 x 72 Gown**

Price per 120

OC36, OC54 – Open Bottom  
OC72 – Closed Bottom

### SHIRT – BLOUSE – SWEATER BAGS



Made of 1 Mil Polyethylene – Clear Poly Bags protects  
shirts, lingerie, sweaters from dirt and unnecessary  
markings. Packed 2500 per box. 1" lip.

**FB12 – 9-1/2"x12" Underwear**  
**FB11 – 11"x14" T Shirts**  
**FB17 – 13"x17" Shirts, Sweaters**  
**FB20 – 14"x20" Bulky Seaters, Jackets**  
**FB27 – 17"x27" Bulky Coats, etc.**

Prices per 100

Printing Available, 25,000 Minimum. Call for price.

# STEAMERS

Keep your garments fresh – wrinkle-free for a more professional presentation. J6 Steamer is for home or travel usage. J2 and J4000 models are suited for heavier usage in stores or manufacturing facilities. The new J4000 model is an upgraded, improved J3. It uses the same housing but has a sight gauge to check water levels.



## ESTEAM GARMENT STEAMER

**J6** – Esteam hand-held travel steamer is the world's most powerful hand-held steamer recommended for traveling or light touch-up use. It holds 8 ounces of plain tap water and is equipped with a 600 watt heating element, which heats water within 1 minute. This item is a necessity for travel or where space is a premium. The Esteam is available with an optional converter for overseas travel. 3 lbs.

## ELECTRIC SPOT CLEANING GUN

Shoot out stains instantly with our handy spray gun. Removes the toughest stains easily. Keep your stock stain free and ready for sale. Use with #105SAS Spray-A-Spot Cleaning Fluid.

**SG1000**



**EVER BLUM SPRAY-A-SPOT**

Used with SG1000

**105SAS**

gallon  
Cleaning  
Fluid



## STEAM BUTLER 400

**Brand New – Improved**

**ST400** – Newest and most technologically advanced steamer on the market today. Automatic shut-off thermostat control prevents heat element burn-out. 5-1/2 foot plastic hose with heat resistant plastic handle. Unit on casters. Three-quarter gallon unbreakable PVC container. 1 year warranty.

**ST400**

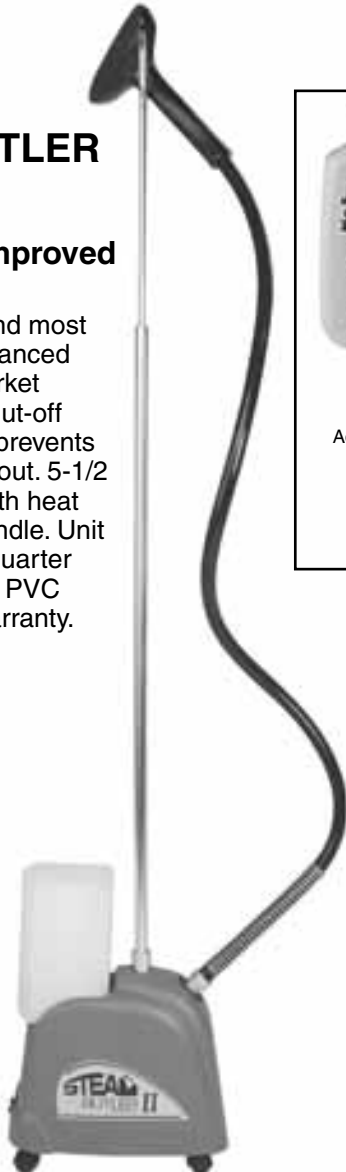

**JIFFY  
STEAMER CLEANER**

Add to water to keep steamer clean from minerals. 8 oz.

**JC8**

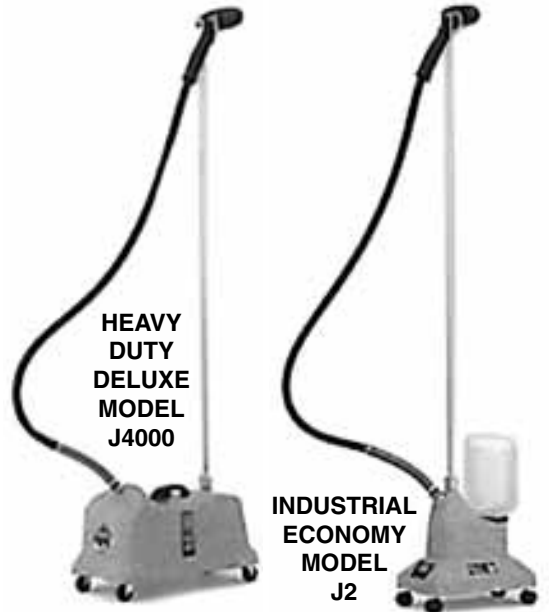

**HEAVY  
DUTY  
DELUXE  
MODEL  
J4000**

**INDUSTRIAL  
ECONOMY  
MODEL  
J2**

**J2 – INDUSTRIAL ECONOMY MODEL JIFFY APPAREL AND UPHOLSTERY STEAMER** – Jiffy performance with budget price for operations that do not need the complete flexibility and heavy duty construction of the deluxe model. An ideal second steamer for overload days or for home use. Has removable hose hanger rod. Plastic contour handle grip. Heavy duty wiring. Durable lightweight gallon plastic water bottle. 1350-W/120-V AC (220-40-V on request). Shipping weight 23 pounds.

**J4000 – HEAVY DUTY DELUXE MODEL** – For all types of wearing apparel and upholstery. Has removable hose hanger rod. Special full flow nozzle for even spray. Contour handle grip. Dual thermostats for steam in seconds after preheating. Heavy duty three-position control switch. Heavy duty wiring. Heavy gauge aluminum and brass water tank and housing. New sight gauge to check on water level and sediment. Attractive finish. 1550-W/120-V AC (220-40-V on request). Shipping weight 29 pounds.

**J2B – Replacement bottle for J2**

**JHose – Replacement Head/Hose Attachment, 5-1/2 feet long**



# THE LEAST EXPENSIVE AND MOST POPULAR RACKS EVER!!

Versatile, lightweight, low cost, the most practical racks at such low prices, engineered to withstand heavy loads. Each rack is 24" wide at base with 1" dia. tubing. 900 series and 903 racks have decorator black baked enamel finished uprights and chrome hangrails and fittings. A Great Value!!

IN STOCK FOR IMMEDIATE DELIVERY

## DOUBLE TIER RACK

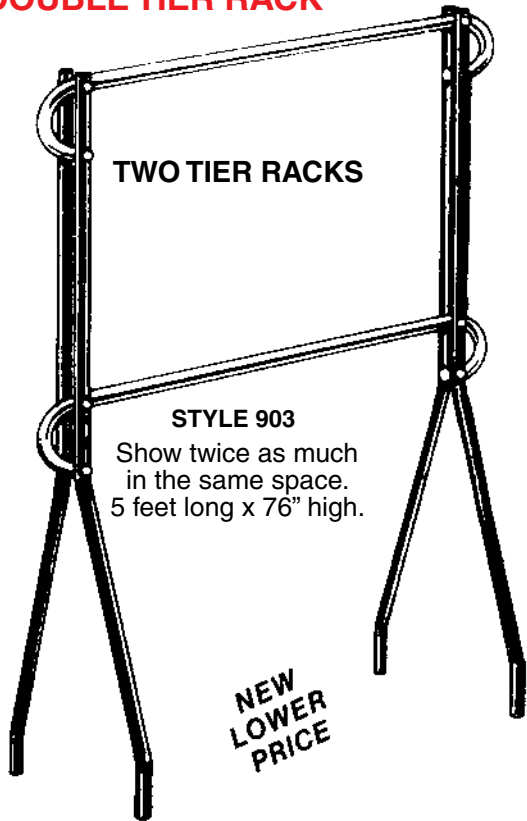

TWO TIER RACKS

STYLE 903

Show twice as much in the same space. 5 feet long x 76" high.

NEW LOWER PRICE

## WHEELS



900W  
Mobilizes Racks  
900 & 903

## SINGLE BAR

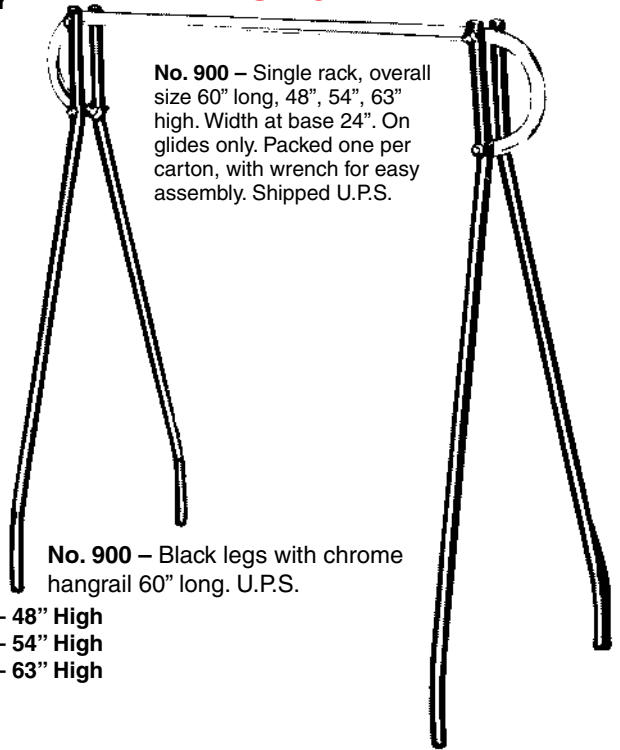

No. 900 - Single rack, overall size 60" long, 48", 54", 63" high. Width at base 24". On glides only. Packed one per carton, with wrench for easy assembly. Shipped U.P.S.

No. 900 - Black legs with chrome hangrail 60" long. U.P.S.

900A - 48" High  
900B - 54" High  
900C - 63" High

## INDUSTRIAL GARMENT CENTER WAREHOUSE RACK

GCR - SUPERIOR WAREHOUSE RACK

72" long x 68" high. Heavy-duty welded angle bar base. 1-5/16" outside diameter tubing. Knocks down for storage. High polish chrome finish. 4" casters.

GCR

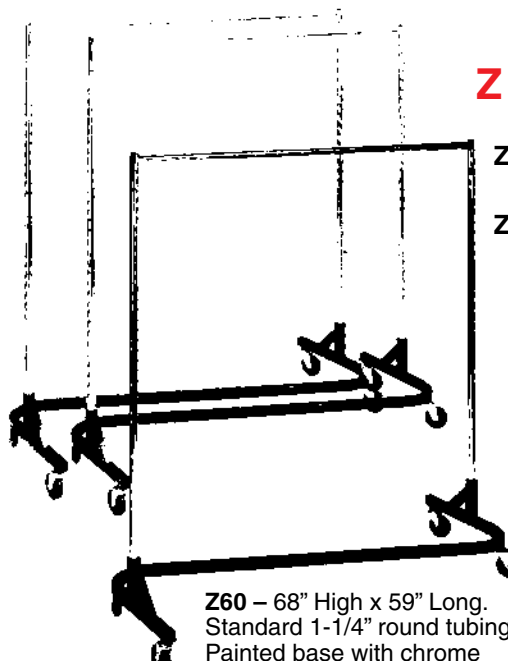

## Z RACKS

Z60 - 1-1/4" Round Tubing, K.D. base.

Z60S - 1-1/4" Round Tubing, Solid one piece base.

## NESTING STOCK ROOM RACKS

*Space saving design allows for easy storage when not in use*

Z60 - 68" High x 59" Long. Standard 1-1/4" round tubing. Painted base with chrome upright. K.D. base.

ZH60 - 60" long add on hangbar converts Z60 into a double tier rack.

Z60S - Heavy-duty 1-1/4" round tubing uprights. 68" high x 59" long. Solid one piece base.

ZE12 - 12" height extenders

## SALESMAN'S COLLAPSIBLE RACK

## SCREEN FOR SALESMAN'S RACK

## HEAVY DUTY 1" SQUARE TUBING SALESMAN'S COLLAPSIBLE RACK

### HEAVYWEIGHT MODEL

**SWF** – Round Tubing.  
Collapsible and adjustable.  
Adjusts from 48" to 65" high.  
Uprights are 48" apart. 12" pullout on each side. Sets up or folds down in seconds. No tools necessary. 4" wheels.

**SWF**

**TA6** – 6" Height Extender

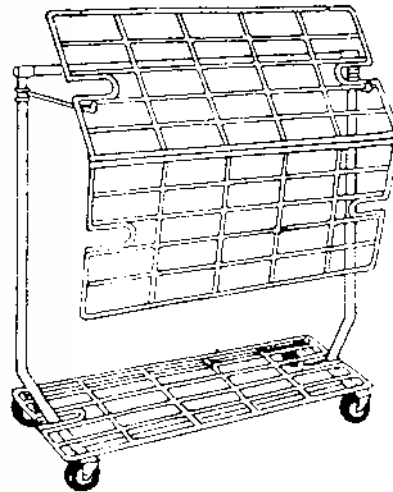

**RCA/5** – Can be used either as a Shelf or Display Screen for SWF (Salesman's Rack) at left. All chrome plated. Easy to set up. Adds a new dimension to your presentations.



**RCW/4**

**RCW/4** – 1" Square Tubing. Collapsible and adjustable. Adjusts from 48" to 65" high. Uprights are 48" apart. 12" pullout on each side. Sets up or knocks down in seconds. No tools necessary. 4" wheels.

**SWFKD** – Lighter weight version of SWF above. Comes knocked down, you set up. After set-up, collapses for storage same as SWF. Smaller carton to save on freight.

**SWFKD**

See Salesman's Tripod Rack – Page 21  
See Double Bar Collapsible SWF/2 – Page 32

## SINGLE BAR HEAVY DUTY GARMENT RACK

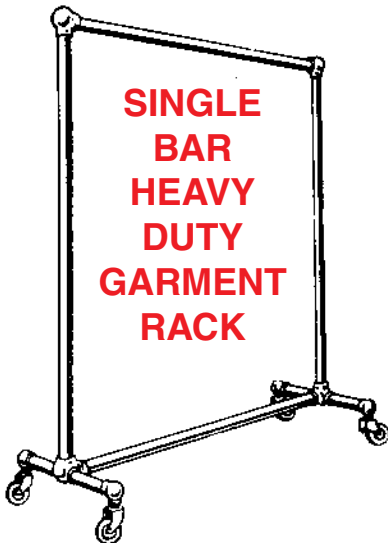

**LC** – Locking Casters  
Available per caster  
additional to price of rack.

All SB & TS Racks  
are available in heavier  
1-1/4" tubing.

Add \$25.00  
to price of rack.

Please specify 1-1/4" and  
model # when ordering.

## DOUBLE TIER HEAVY DUTY RACK

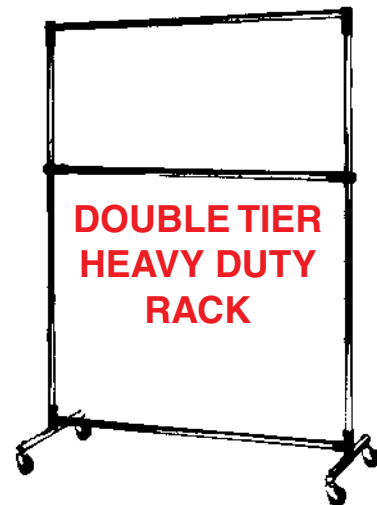

**STYLE SB** – The heaviest single bar rack in the market. Style SB can be made to your own specifications. Call for quote. Available in polished chrome or galvanized finish. Heavy-duty 4" wheels. 1" dia. tubing. Shipped KD UPS. All orders of 5 racks or more, deduct 5%.

Galvanized Chrome

**SB1** 48" High x 48" Long  
**SB2** 48" High x 60" Long  
**SB3** 48" High x 72" Long  
**SB4** 63" High x 48" Long  
**SB5** 63" High x 60" Long  
**SB6** 63" High x 72" Long

**SB & TS RACKS CAN BE MADE ACCORDING TO SPECIFICATIONS.**

**ANY LENGTH OR HEIGHT CAN BE MADE.**

**AVAILABLE IN 1-1/4" DIA. TUBING, Add \$25.00 per rack**

**STYLE TS** – A very popular, versatile fixture! Hang more in less floor space. Hang two levels of pants, blouses, etc. Terrific for gowns, long coats, as center bar adjusts to any height or can be removed completely. Heavy-duty 4" wheels allow you to move this rack easily. Stands a full 73" high and is available in three lengths. 1" dia. tubing. Style TS can be made to your own specifications. Available in polished chrome or galvanized. Allow three business days for delivery. Shipped UPS. All orders for 5 or more deduct 5%.

Galvanized Chrome

**TS1** 48" Long x 73" High  
**TS2** 60" Long x 73" High  
**TS3** 72" Long x 73" High

# ADJUSTABLE 4-WAY DISPLAYERS

These Displayers have a beautiful mirror chrome finish. Perfect for display of any combination of men's, ladies' or kidswear. All garments are displayed in full view. Each arm is independently adjustable every 3" from 48" to 72" high. Base and frame are made of heavy duty 1" square tubing. Adjustable arms are made of 0.083" square tubing. Each rack comes with adjustable levelers. All arms on this page are interchangeable. Ball casters (page 34) mobilize these racks.



**#36 – 4 WAY STRAIGHT ARM DISPLAYER**  
Arms are 16" long.

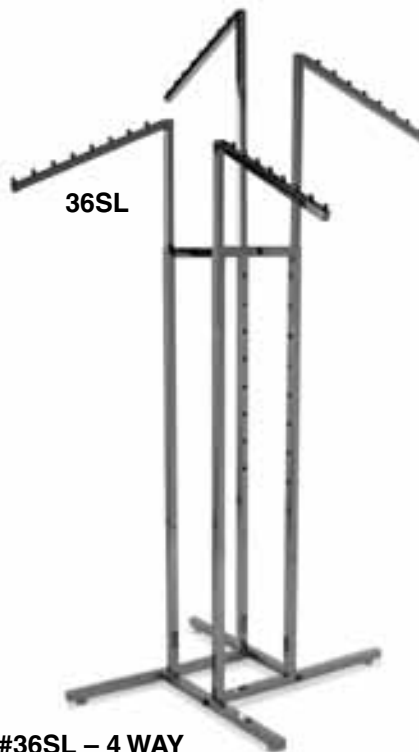

**#36SL – 4 WAY SLANT ARM DISPLAYER**  
Slanted arms are 18" long with 8 balls each arm.



**#K12 – 4 WAY STRAIGHT & SLANT ARM DISPLAYER**  
Has 2-16" straight arms and 2-18" slant arms with 8 balls on each arm.

For Matching 2-Way Displayer,  
See Page 32

For Matching 2-Way Displayer,  
See Page 32

For Matching 2-Way Displayer,  
See Page 32

## WATERFALL ATTACHMENTS

Add hanging space!!  
Display arms fit onto frames  
of any 4 way rack on  
this page.

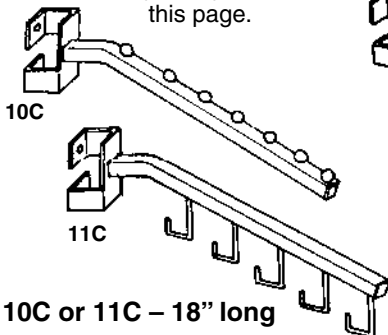

## STRAIGHT ARM ADD-ON

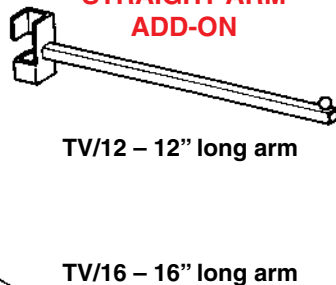

## CHROME RACK TOPPERS

Convert the Tops of Your Racks  
into Lucrative Display Areas!

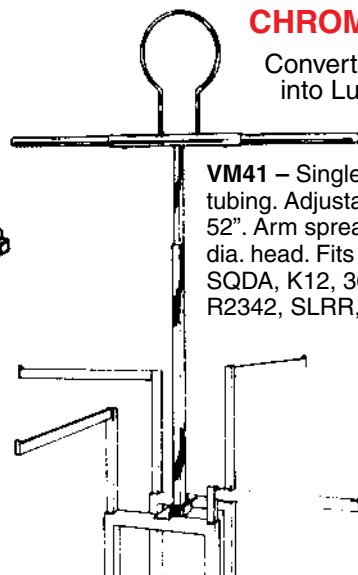

**VM41** – Single form fits onto 1" square tubing. Adjustable height from 37" to 52". Arm spread 36". Snap out arms, 8" dia. head. Fits atop the following racks: SQDA, K12, 36, 36SL, K80, K82, R2336, R2342, SLRR, SQV & TR1.

# ELEGANT ALL CHROME DISPLAY FIXTURES



## DS - 2 ARM STRAIGHT DISPLAYER

- Polished mirror chrome finish
- Heavy 12"x15" chrome base
- Two 16" straight arms, adjustable to 48"-72"

DS



## DS1 - 2 ARM SLANT DISPLAYER

- Polished mirror chrome finish
- Heavy 12"x15" chrome base
- Two 16" slant arms independently adjustable
- Eight balls on each arm

DS1

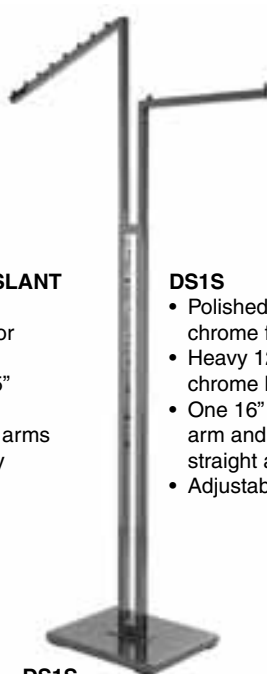

## DS1S

- Polished mirror chrome finish
- Heavy 12"x15" chrome base
- One 16" slant arm and one 16" straight arm
- Adjustable

DS1S

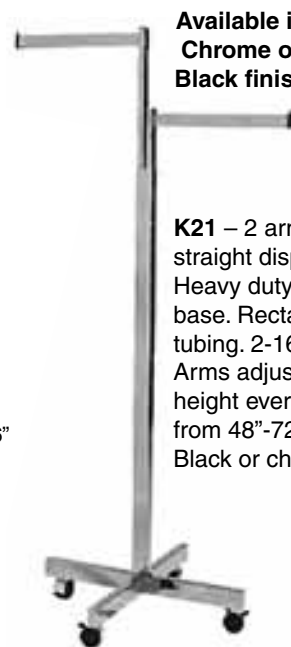

Available in Chrome or Black finish

**K21** - 2 arm straight displayer. Heavy duty X style base. Rectangular tubing. 2-16" arms. Arms adjustable in height every 3" from 48"-72". Black or chrome.

K21X - Chrome

K21B Black finish

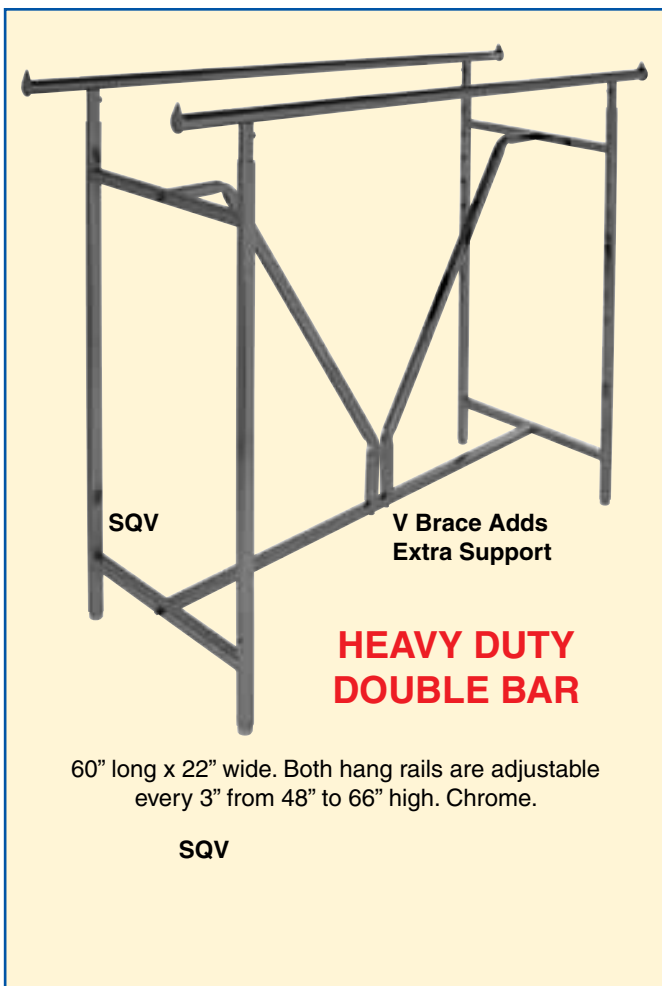

SQU

V Brace Adds Extra Support

## HEAVY DUTY DOUBLE BAR

60" long x 22" wide. Both hang rails are adjustable every 3" from 48" to 66" high. Chrome.

SQU

## DOUBLE BAR COLLAPSIBLE RACK

Works just like SWF Single Bar Collapsible Rack (page 29). Folds away for quick storage. Sets up in seconds without tools.



SWF/2 - Double Bar Fold Away

- 2 - 48" hangrails
- 4 - 12" pullouts
- 22" wide
- Chrome
- Adjustable height 55, 60, & 65"
- 4" wheels

# PARALLEL BAR RACK

Incredibly versatile SQDA rack with possible attachments and variations.  
All attachments fit onto SQV on preceding page also.

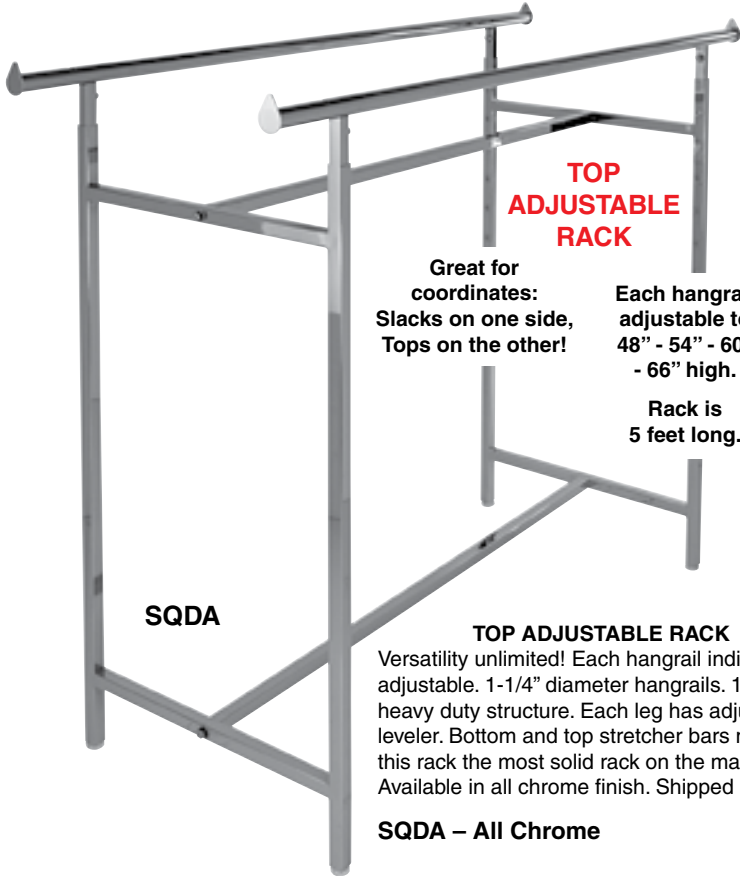

## TOP ADJUSTABLE RACK

Great for coordinates:  
Slacks on one side,  
Tops on the other!

Each hangrail adjustable to  
48" - 54" - 60" - 66" high.

Rack is  
5 feet long.

SQDA

## TOP ADJUSTABLE RACK

Versatility unlimited! Each hangrail individually adjustable. 1-1/4" diameter hangrails. 1" square heavy duty structure. Each leg has adjustable leveler. Bottom and top stretcher bars make this rack the most solid rack on the market. Available in all chrome finish. Shipped U.P.S.

SQDA – All Chrome



## ADD A TOP

**K49** – Add a top to SQDA or SQV racks. Clamp onto hangrails. 60" long. Adjustable in height from 29" to 38". Use as additional hangrail or add waterfalls as illustrated below. K49 works only with SQDA and SQV racks.



AOL

## ADD A LEVEL

**AOL** – Double your SQDA or SQV hanging space. Chrome 5 foot hangrail attachments create twice the amount of hanging space.

## ADD-ON HANGRAILS

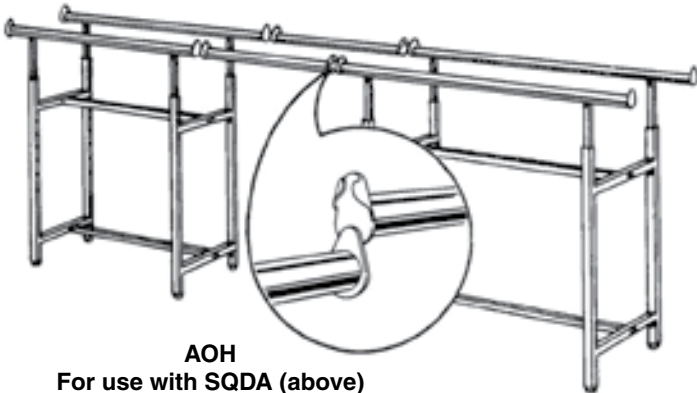

AOH

For use with SQDA (above)  
or SQV (page 32)

Convert 2 racks into 3 racks at 1/2 the cost. Polished chrome, 1-1/4" dia.

AOH

## CHROME GRID RACK TOPPER



Maximize your selling space. Ideal for accessories & related items. Topper is 23" x 54" long & has a 3" lip. Topper fits atop SQDA (page 33) SQV (page 32).

SQDAT



# ROUND RACKS

Round or Rectangular Tubing Hangrail.  
36" and 42" Diameter Round Racks shown with possible attachments and variations.

## ACCESSORIES

### FORMICA OR GLASS TOPS

30" diameter White or Maple Formica Top.  
Use with R23 model (left) or R436 (page 35).

MIC30 - White  
MIC30B - Black  
MIC30M - Maple (Add \$6.00 per piece.)



GT30 – 30" diameter glass top. For use with R23 model (left) or R436 (page 35).

GT36 – 36" diameter glass top. For use with 42" round rack.

### THE MOST POPULAR ROUND RACK

Available with 1-1/4" dia. round hangrail or 1/2" x 1-1/2" rectangular hangrail.

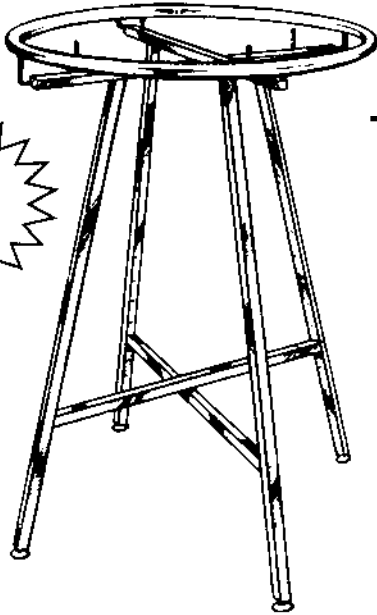

SS – Shelf supports for support of MIC30 or GT30. (set of 4)

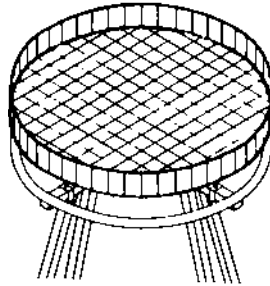

### GRID TRAY TOPPER

GR30 – 30" diameter Grid Tray has 3" lip all around to prevent merchandise from falling off. Adjustable brace fits 36" or 42" rack shown above. Chrome finish.

### CIRCULAR ADJUSTABLE FOLDUP RACK

Retailers prefer this popular rack because it sets up and knocks down easily. No bolts. No tools necessary. Rack is adjustable from 48"-66" every 4". Comes either with a 36" or 42" diameter non-revolving hangrail. 1-1/4" dia. chrome hangrail or 1/2" x 1-1/2" rectangular tubing.

Round Hangrail – 1 1/4" Dia.

R2336 – 36" Dia.

R2342 – 42" Dia.

Rectangular Hangrail – 1/2" x 1 1/2" Dia.

K71 – 36" Dia.

K73 – 42" Dia.

## MOBILE MERCHANDISING

Wheels have either 5/16" or 3/8" diameter thread.

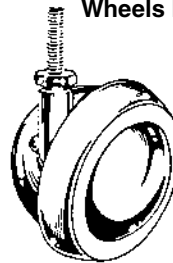

Ball Caster

BC10  
BC10B  
BC58  
BC58B

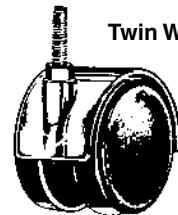

Twin Wheel

TW10  
TW12  
TW12L

2 1/2" DIAMETER  
All Chrome Metal Casters

BC10 – 1" high x 5/16" dia. thread

BC10B – 1" high x 3/8" dia. thread

BC58 – 5/8" high x 5/16" dia. thread

BC58B – 5/8" high x 3/8" dia. thread

## ADD-ON HANGRAIL

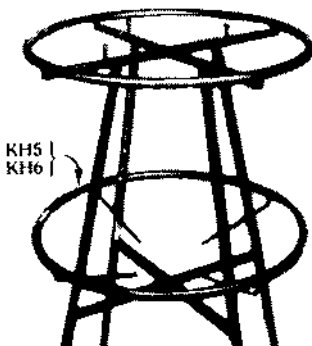

KH5 |  
KH6 |

### ADD-ON RINGS

KH5 – 36" Diameter Ring Turns R2336 (Above) Into a Double Level Rack

KH6 – 42" Diameter Ring Turns R2342 (Above) into a Double Level Rack

### TWIN WHEEL CASTERS WITHOUT LOCKS

TW10 – 2" twin wheel, 1" stem, 5/16" dia. thread

TW10A – 2" twin wheel, 1" stem, 3/8" thread

### TWIN WHEEL CASTERS WITH LOCKS

TW12L – 2" twin wheel, 1" stem, 5/16" dia. thread

TW12LA – 2" twin wheel, 1" stem, 3/8" thread

Wheel has a lock to prevent moving.

Castors above fit all racks pages 31 through 37.

# ADJUSTABLE QUALITY FIXTURES

TOP OF THE LINE RACKS.  
DURABLE, BEAUTIFUL, ECONOMICAL  
ENHANCES THE SALABILITY OF  
YOUR GARMENTS!!!

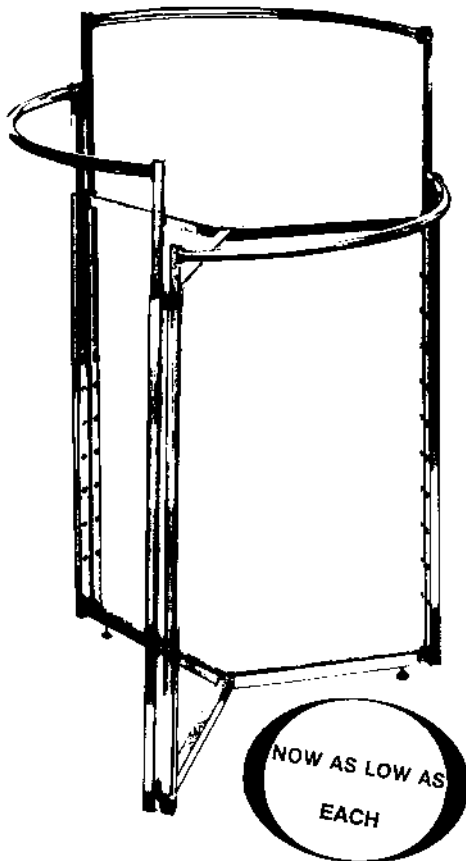

## THREE LEVEL ROUND RACK

Beautiful All Chrome Fixture that will add versatility to any store. Solid, dependable and priced right!! Three independently adjustable arcs. Adjustable from 48"-72" every 3". 3LRR uses 1 1/4" diameter round hangrail either in 36" or 42" diameter.

1 1/4" Diameter Round Tubing Hangrail

3LRR36 - 36" diameter 3LRR42 - 42" diameter

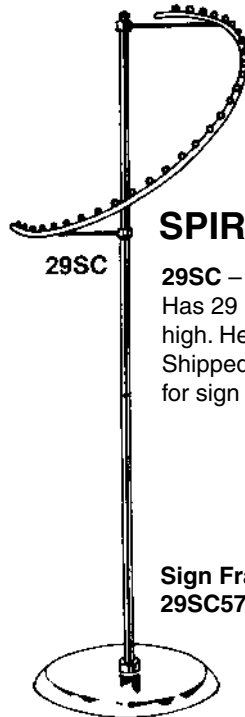

29SC

## SPIRAL COSTUMER

29SC - All chrome costumer. Has 29 balls and stands 62" high. Heavy 18" diameter base. Shipped UPS. Has fitting on top for sign holder.

Sign Frame for Top of Spiral Costumer  
29SC57 - 5-1/2" x 7" frame, 3" stem.

## FIVE TIER REVOLVING HOSIERY RACK

HD5T - Black color base and pole. Has five silver color tiers with six 6-1/4" hooks each. Thirty hooks per rack. Tiers can be deducted or added (call for price).

HD5T

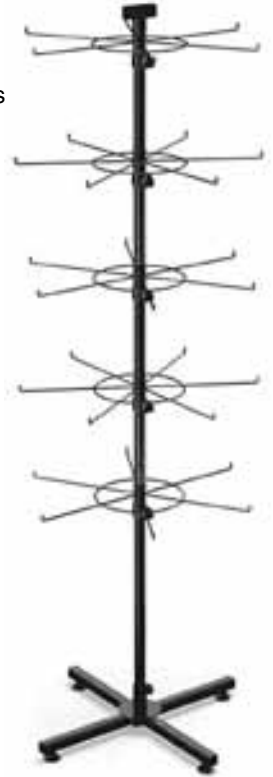

## FINEST QUALITY ADJUSTABLE, REVOLVING GARMENT RACK

R436

36" diameter chrome hangrail with matching chrome base. The strongest and most versatile revolving rack in the industry.

Optional - 30" Diameter  
White, Maple or Black  
Formica Top

MIC30 - White  
MIC30B - Black  
MIC30M - Maple

R436 - All Chrome 36" dia.

- 4 legged welded base
- Adjustable 48"-64"
- Revolving hangrail ball bearing mounted
- Shelf rests and levelers included

30" or 36" Diameter  
Glass Top

GT30 - 30" dia., 3/16"

GT36 - 36" dia., 3/16"

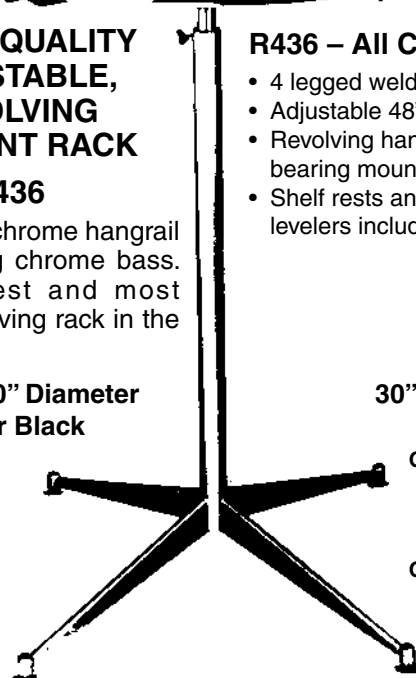

# ADJUSTABLE CHROME FIXTURES

## SPACE SAVER

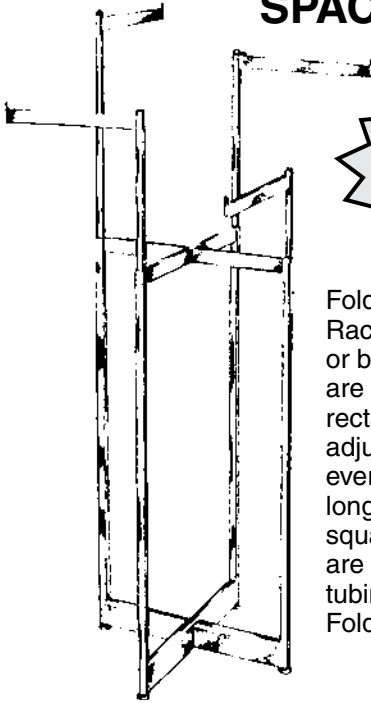

Great for  
Kidswear

Fold Away Space Saver Rack requires no screws or bolts to set up. Arms are made of 1/2" x 1-1/2" rectangular tubing. Arms adjust from 48" to 72" every 3". Arms are 16" long. Uprights are 1" square tubing. Crossbars are 1" x 2" rectangular tubing chrome finish. Folds flat for easy storage.

**K150**

## HALF ROUNDER ADJUSTABLE

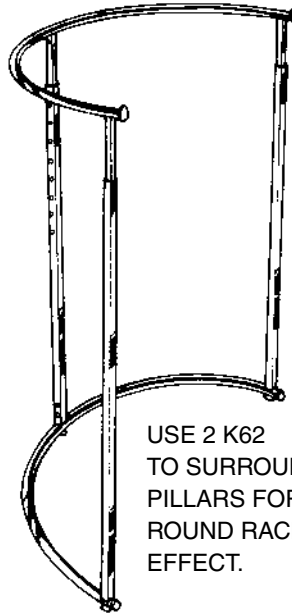

**K62** – Half Rounder adjustable every 3" from 49" to 73". Has adjustable levelers and tear drop ends. AOH (Add On Hangrail), page 33, can be used with this rack. K62 has a 43" diameter hangrail.

USE 2 K62  
TO SURROUND  
PILLARS FOR  
ROUND RACK  
EFFECT.

## SINGLE HANGRAIL ROLLING RACK



**K43**

**K43** – Hangrail is 1-1/4" diameter. Round tubing and is adjustable from 54" to 74". Uprights and stretchers bars and base are made of 1" square tubing. 60" long, 20" wide at base. All chrome. (3" casters).

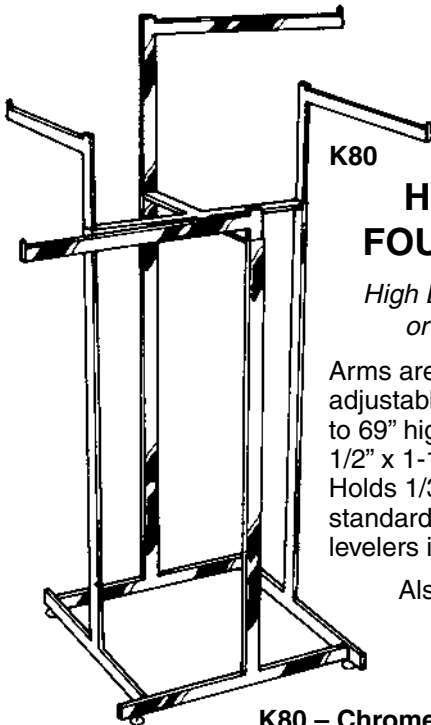

**K80**

## HI-CAPACITY FOUR ARM RACK

*High Luster Chrome Finish  
or Matt Black Finish*

Arms are 22" long and adjustable every 3" from 48" to 69" high. Arms are made of 1/2" x 1-1/2" rectangular tubing. Holds 1/3 more garments than standard 4-way rack. Adjustable levelers included.

Also available with 16" arms.

**Style K80X16**

**K80** – Chrome Finish  
**K80MAB** – Black Finish

**RU/22** – Add on straight arm attachment, 22" long, for use with K80 or K82 rack.

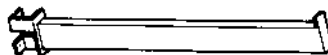

# RECTANGULAR TUBING 4 WAY RACKS

**SQUARE (1" x 1") TUBING BASE  
WITH FOUR RECTANGULAR ARMS (1/2" x 1-1/2")  
HIGH LUSTER CHROME FINISH**

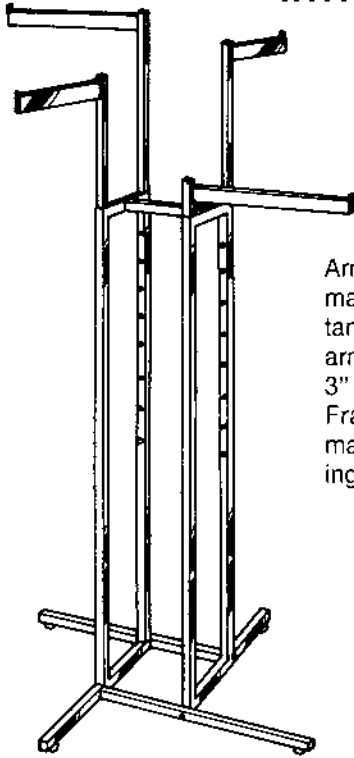

**New  
Lower  
Prices**

**K13 - 4 Arm  
Displayer**

Arms are 16" long and made of 1/2"x1 1/2" rectangular tubing. Each arm is adjustable every 3" from 48"-72" high. Frame and legs are made of 1" square tubing. Levelers included.

**K13**

**Save Money!  
Square tubing 4 Ways  
See page 31**

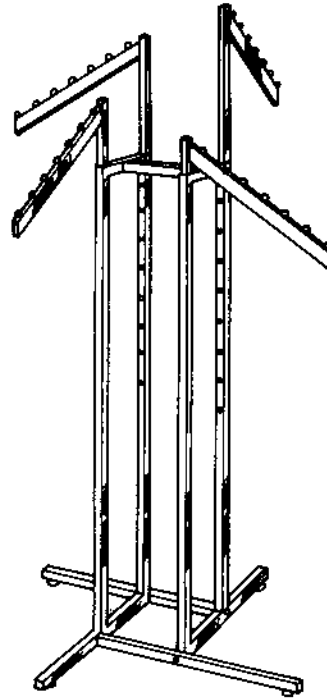

**New  
Lower  
Prices**

**K14 - 4 Arm  
Slant Displayers**

Arms are 18" long and made of 1/2"x1 1/2" rectangular tubing. Each arm has 7 balls, each arm is adjustable every 3" from 48"-72" high. Frame & legs are made of 1" square tubing. Levelers included.

**K14**

**Save Money!  
Square tubing 4 Ways  
See page 31**

## Stock Transfer Rack

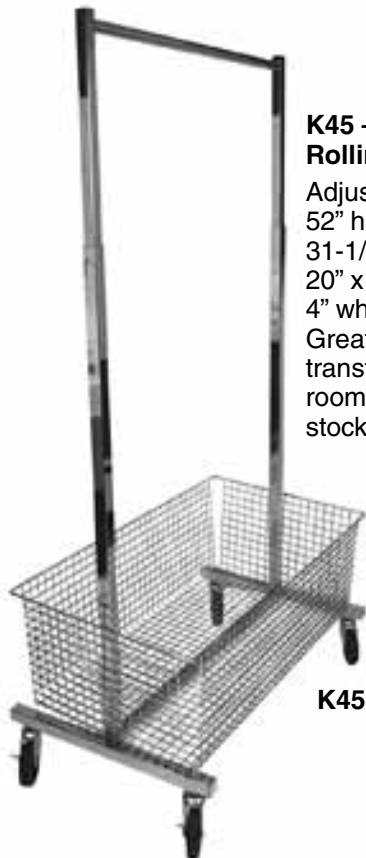

**K45 - Chrome  
Rolling Rack**

Adjustable from 52" high - 68" high. 31-1/2" hangrail, 20" x 35" basket, 4" wheels. Great for in stock transfer from fitting room, cash wrap, stock room.

**K45**

## Lingerie Tower

**High Luster Chrome Finish**

Available with rectangular arms or round tubing arms.



**K36 -  
Folding Lingerie Tower**  
Constructed of 1" square tubing. Includes 16 twist on 1/2" x 7/8" rectangular tubing arms. Arms are 12" long, 61" high. Adjustable levelers. 3/8" fitting for card frames.

**K36  
Rectangular Arms**

**K35  
Round Tubing Arms**

# DESIGNER 400 SERIES

Versatile merchandisers combine folded and hanging apparel for maximum display of matching sets. Fixtures come complete with black frame, brackets, hangrails, shelves and casters. Choice of finish on shelves: black, white, almond, or gray.



K411

## PARALLEL BAR PLAYER

Fixture made of 1" square tubing. Includes: 16 brackets, 8 - 24" shelves, 2 - 36" chrome hangrails. Black frame. Choice of black, white, almond, or gray shelves. 54" high x 24" wide.

- K411BB - Black/Black
- K411BW - Black/White
- K411BAL - Black/Almond
- K411BGY - Black/Gray

## F DISPLAYER

Fixture made of 1" x 2" rectangular tubing. Includes: 8 - 12" brackets, 4 - 24" shelves, casters. Black frame. Choice of black, white, almond, or gray shelves. 56" high x 24" wide.

- K400BB - Black/Black
- K400BW - Black/White
- K400BAL - Black/Almond
- K400BGY - Black/Gray



K400



K410

## T BAR DISPLAYER

Fixture made of 1" square tubing. Includes: 8 - 12" brackets, 4 - 24" shelves, casters. Black frame. Choice of black, white, almond, or gray shelves. 24" wide x 27" deep.

- K410BB - Black/Black
- K410BW - Black/White
- K410BAL - Black/Almond
- K410BGY - Black/Gray

# BAUHAUS SERIES

## Display Racks



### SINGLE BAR MERCHANDISER

Adjust from 48" to 72". Uprights are 1" x 3" tubing. Handrail is 1 1/4" Dia. x 48" L with puck ends. Levelers included. Finish is satin chrome. BA45SC

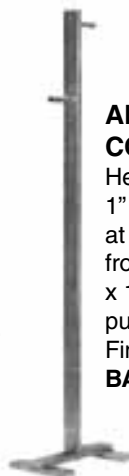

### ADJUSTABLE COSTUMER

Height 74". Upright is 1" x 3" tubing with holes at 72", 60", 48" and 36" from floor. Includes 26" x 1" Dia. faceouts with puck ends and levelers. Finish is satin chrome. BA46SC

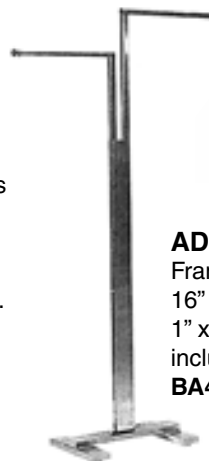

### ADJUSTABLE TWO WAY RACK

Frame height 46" min to 75" max. Arms are 16" L x 1" round with puck ends. Upright is 1" x 3". Tubing base is 24" x 24". Levelers included. Finish is satin chrome. BA48SC

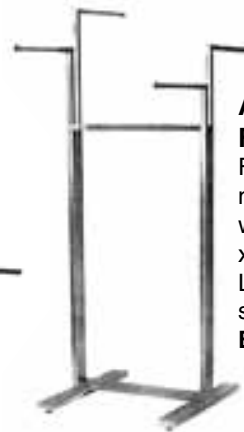

### ADJUSTABLE FOUR WAY RACK

Frame height 46" min to 75" max. Arms are 16" L x 1" round with puck ends. Upright is 1" x 3". Tubing base is 24" x 24". Levelers included. Finish is satin chrome. BA47SC

Bauhaus Series also available with curved hangrails.



# VERSATILE FIXTURES

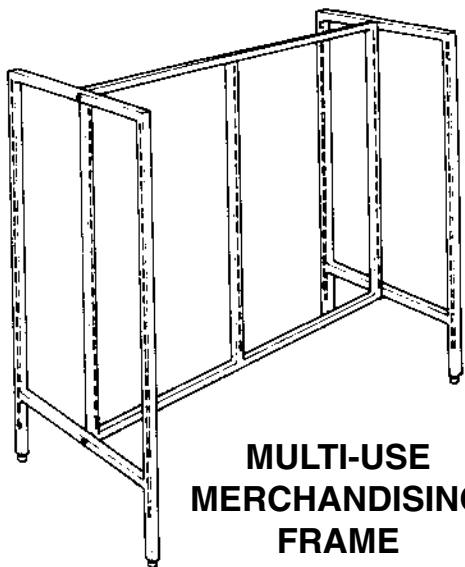

**MULTI-USE  
MERCHANDISING  
FRAME**

Adjustable in height from 48" to 69". 1" sq. tubing, all chrome. Display goods on hangrails or shelves. Slotting is 1/2" slot on 1" centers. Adjustable levelers. Height adjustable every 3" from 58" to 63". Floor space needed is 24-1/2" x 62-1/2".

**K6403**

## COMPONENTS FOR K6403

**Hangrail Bar** – Use 2-5634 (page 64) and 1 TBE60 (page 63). Or use rectangular tubing (page 66).

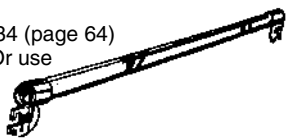

**Glass Shelves** – Use glass shelves (page 67) 12" x 60" long and 3-GA10 brackets (page 65).

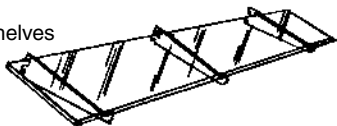

## HANDBAG DISPLAYER

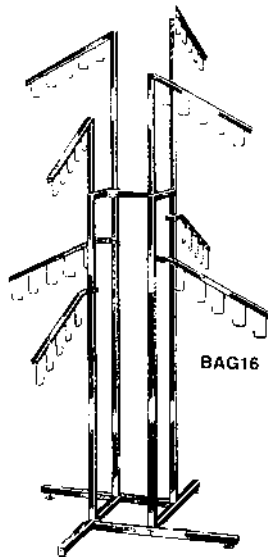

**BAG  
DISPLAYER**

**BAG16** – All chrome. Four adjustable arms. Four-five hook waterfalls.

Also available with straight arms with hooks (K88). Call for price.

# CAP TOWERS

## CapTower Floor Display

CapTower, our fashionable tower of caps, attracts more customers, makes shopping more convenient and saves you precious floor space. Customers can easily see the logos they're looking for – and can easily access caps. Weighted base prevents tower from tipping over. A must-have when style is essential and space is tight. Black finish. *Patent pending.* 78" H x 10" W x 15-1/2" D

**1640 – CapTower Floor Display**



## CapTower For Counters

Increase sales with CapTower, the fashionable counter tower rack that allows you to sell up to six dozen caps – especially when space is tight. Unlike many other racks, CapTower lets customer easily see logos and easily access caps. *Patent pending.* 38" H x 10" W x 15-1/2" D

**1645 – CapTower Counter**

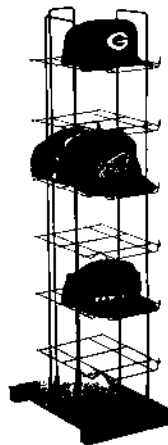

# BELT AND TIE RACKS

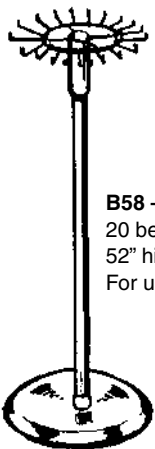

**B58** – Revolving Belt Rack. 20 belt hooks, 18" base, 52" high. Top is threaded. For use with card holder.

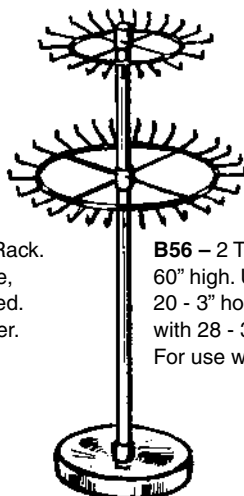

**B56** – 2 Tier Revolving Belt Rack. 60" high. Upper Ring - 19" dia. with 20 - 3" hooks. Lower Ring - 27" dia. with 28 - 3" hooks. Top is threaded. For use with card holder.

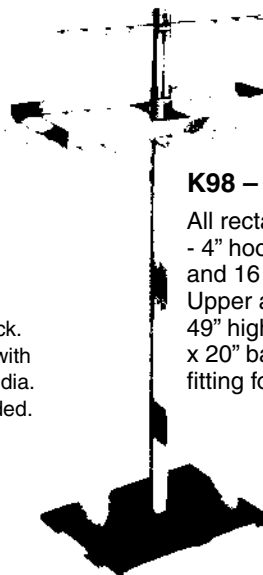

## K98 – BELT AND TIE RACK

All rectangular tubing. Has 32 - 4" hooks on bottom rectangle and 16 - 4" hooks on upper arm. Upper arm is adjustable from 49" high to 58" high. Heavy 15" x 20" base. Has 3/8" threaded fitting for card. All chrome.

**K98**

# HAT, HOSIERY AND SHOE RACKS

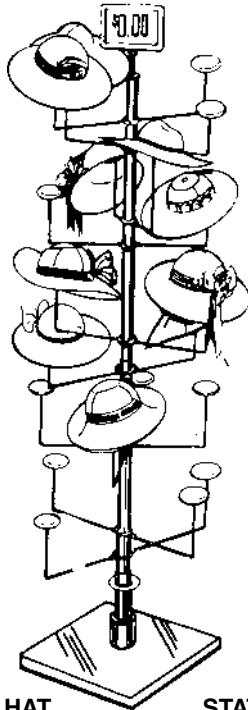

**REVOLVING HAT  
ALL CHROME DISPLAYER  
Floor Displayer**

Holds 20 hats, all chrome plated, revolving unit. 18" square base for extra support. 72" high. Has foam covered hat holders.

**HD1822** — 20 hat capacity

**STATIONARY HAT  
ALL CHROME DISPLAYER  
Floor Displayer**

Holds 20 hats, all chrome plated, stationary unit. 18" square base for extra support. 72" high. Has foam covered hat holders.

**K26** — 20 hat capacity

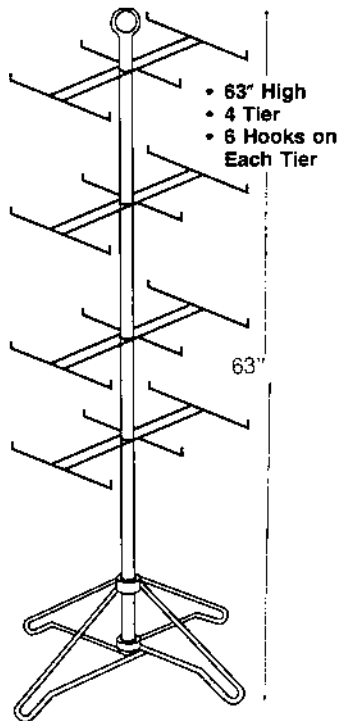

**REVOLVING  
PACKAGED GOODS  
RACK**

For panty hose, socks, or any packaged item. Chrome.

**145-BB2**



**4 TIER SPINNER**

4-22" Diameter Baskets  
8" Deep. 66" High. Black.

**1935**



**COLLAPSIBLE  
SHOE RACK**

Diagonal support bar for extra stability. Has 8 - 12" x 48" adjustable shelves. 48" long x 66" high. Truck shipment.

**K48**



**SHIRT RACK**

4 Shelves, 22" Wide x 13" Deep, 55" High. Shelves can be level or on a slant. Black.

**SR1**

# LADDER SYSTEM WALL UNITS & DISPLAYERS

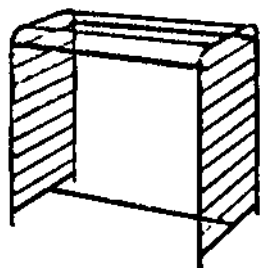

## DOUBLE CENTER FLOOR RACK

28" wide x 48" long x 58" high.

A301/B - Black

## TOWER LADDER UNITS

14" wide with 18" x 22" base, 73" high.

A306/B - Black

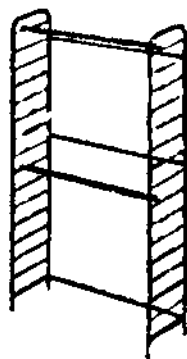
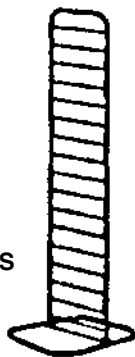

## SINGLE TWO TIER WALL UNIT

16" wide x 48" long x 88" high. Includes two hangrails.

A304/B - Black

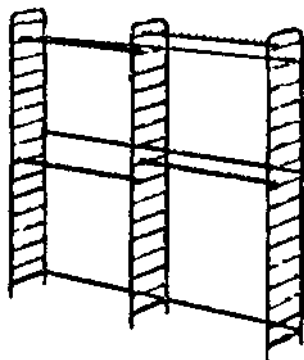

## DOUBLE TWO TIER WALL UNIT

16" wide x 96" long x 88" high. Includes four hangrails.

A305/B - Black

## ACCESSORIES



HANGRAIL  
ARL48/B - Black

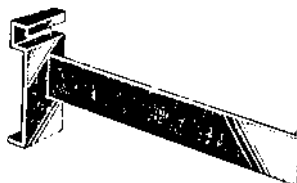

RECTANGULAR TUBING FACE OUT  
AF12/B - 12" Black

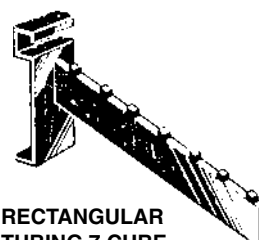

RECTANGULAR TUBING 7 CUBE WATERFALL  
AF7/B - Black

## SHELVING FOR LADDER FIXTURES

AT66/B



TOP SHELF  
For Double Ladder A301  
25" x 48" Shelf

AT66/B - Black

AT77/B

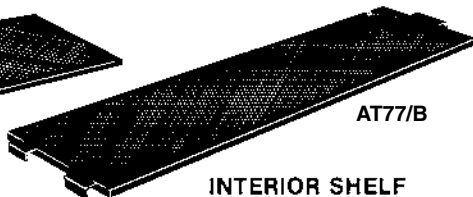

INTERIOR SHELF  
14" x 45" fits Double  
or Single Ladder

AT77/B - Black

AT87/B

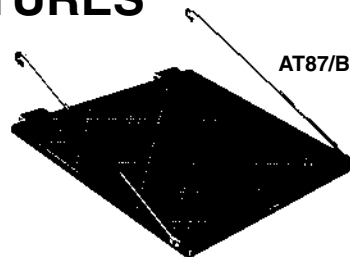

END SHELF  
For A301 (Double) 14" x 25"

AT87/B - Black

# ALTA SYSTEM

Alta System uses satin chrome finish with melamine shelves in a hard rock maple finish. Collection includes 4 Way, Island Merchandiser, Wall Unit, and Nesting Tables.



T502SC  
as shown.  
T502FRSC  
frame only.

## 4 WAY CROSS MERCHANDISER

44" long x 24" wide x 72" high.  
With shelves and brackets.

**T502SC** – With shelves

**T502FRSC** – Without  
shelves and brackets



T503SC-H  
with addition  
of side shelving.

## ISLAND MULTI MERCHANDISER

48" long x 24" wide x 54" high.

With top shelf only.

**T503SC-H** – With top shelf

**T503FRSC** – Frame only



## WALL UNIT

96" high x 50" wide x 16"  
deep. Price is for frame only.  
Add accessories as needed below.

**T500SC**

## ACCESSORIES

Hardware has Satin Chrome  
finish to match (SC).

### T502SC – 4 Way Cross Merchandiser

Shelf, 12" L x 11-3/4" W

**TSF121H**

Tap In Bracket, 10"

**GA10** (Chrome)

Tap In Bracket, 12"

**GA12/SC**

### T503SC-H – Island Merchandiser

Left Bracket, 12"

**GHSL12/SC**

Right Bracket, 12"

**GHSR12/SC**

Hangrail, 4' x 1/2" x 1-1/2"

**RE4-SC**

Long Shelf, 48" L x 13" W

**TSF481H**

### T500SC – Wall Unit

Bracket For Hangrail, 3"

**CR3-SC**

Bracket For Hangrail, 12"

**CR12-SC**

Faceout, 12"

**RH/12-SC**

Waterfall, 7 Cube

**RH/7B-SC**

Hangrail, 4' x 1/2" x 1-1/2"

**RE4-SC**

## DISPLAY TABLES & PEDESTAL

Satin chrome finish, melamine top  
in hard rock maple finish.

**A. T504SC-H** – Pedestal Table  
24" L x 24" W x 42" High

**B. T501SC-H** – Large Display Table  
60" L x 32" W x 30" High

**C. T505SC-H** – Small Display Table  
36" L x 24" W x 24" High

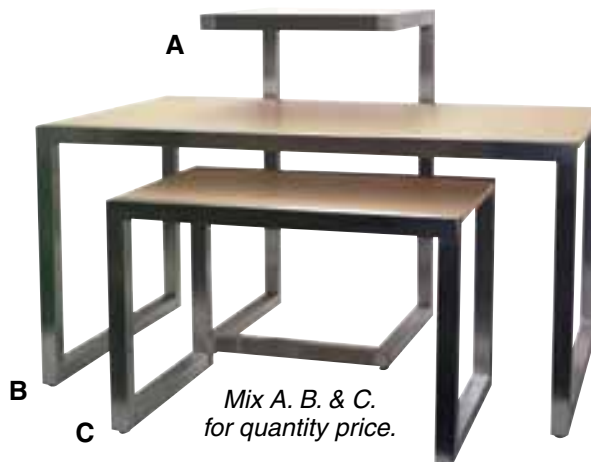

Mix A. B. & C.  
for quantity price.



# VISTA CLASSIC GONDOLA MERCHANDISING SYSTEM

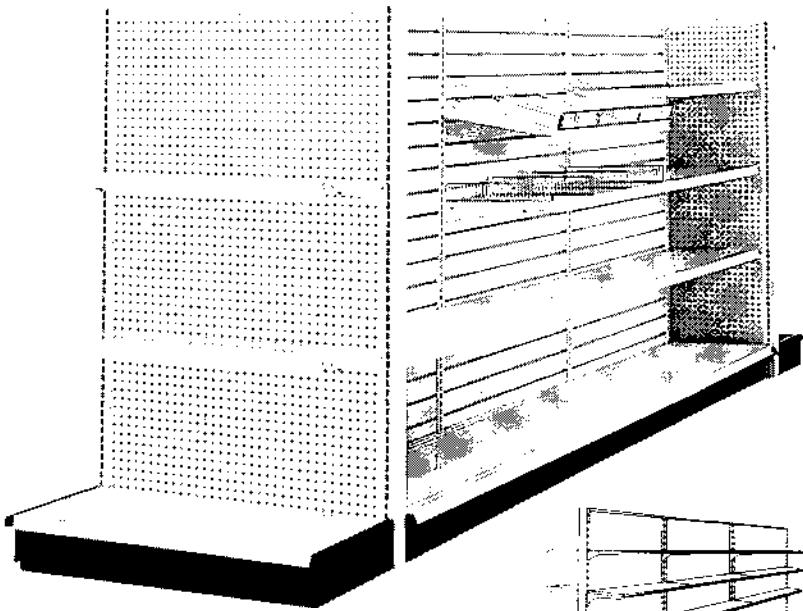

- Choice of colors: Antique White & Black.
- All Gondolas 2', 30", 3' or 4' lengths are same price.
- Base shelf included – 8", 10", 12", 14", 16", 18", 20", 22" or 24".
- Fast assembly. Uprights pre-assembled to base shoes.
- All units available in the following heights – 36", 48", 54", 60", 72", 84" & 96" – Listed below are the most popular heights.

## GONDOLAS

12" or 16" Base Shelves

54" High

Length of Run	36" OA Depth 16" Base Shelves	27" OA Depth 12" Base Shelves
4'	G416S	G422S
8'	G816	G822
12'	G1216	G1222
16'	G1616	G1622
20'	G2016	G2022

72" High

Length of Run	36" OA Depth 16" Base Shelves	27" OA Depth 12" Base Shelves
4'	G41660S	G42260S
8'	G81660	G82260
12'	G121660	G122260
16'	G161660	G162260
20'	G201660	G202260

## END UNITS

Length of Unit	54" High 19" OA Depth 16" Base Shelves	72" High 15" OA Depth 12" Base Shelves
2'	E54-2	E60-2
3'	E54-3	E60-3
4'	E54-4	E60-4

Pegboard panel front and back.

## WALL UNITS

84" High

Length of Run	19" OA Depth 16" Base Shelves	15" OA Depth 12" Base Shelves
4'	W41684	W41284
8'	W81684	W81284
12'	W121684	W121284
16'	W161684	W161284
20'	W201684	W201284

Pegboard panel front only. Back panel additional.

**Heavy duty 1/4" pegboard included.**

**Slatwall Panels Available at Additional Cost**

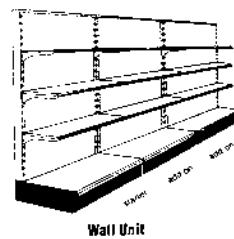
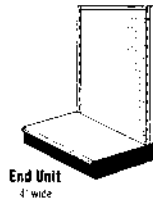
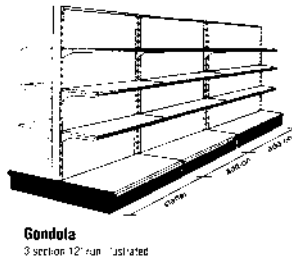

## SHELVES

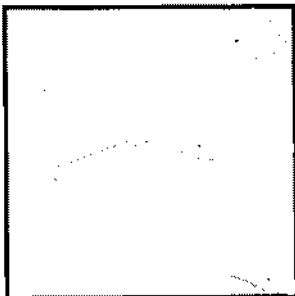

### INTEGRATED UPPER SHELVES AND BRACKETS

Vista upper shelf brackets are welded directly to the shelf and available in two choices, flat or sloped.

48" Shelves		
Size	Item	Price
10"x48"	S1048	
12"x48"	S1248	
14"x48"	S1448	
16"x48"	S1648	
18"x48"	S1848	
20"x48"	S2048	
36" Shelves		
Size	Item	Price
10"x36"	S1036	
12"x36"	S1236	
14"x36"	S1436	
16"x36"	S1636	
18"x36"	S1836	
20"x36"	S2036	

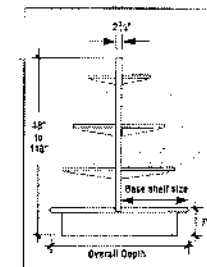

**GONDOLAS**

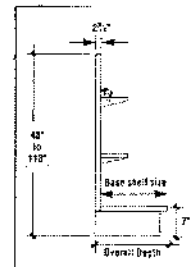

**END UNITS**

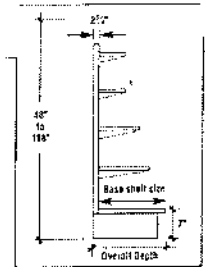

**WALL UNITS**

- Gondolas, End Units, & Wall Units are available in the following heights – 36" 48" 54" 60" 72" 84" & 96"
- All units supplied with heavy duty 1/4" pegboard or solid panel.

**Also Available in Used – Call for Price.**



# PIPELINE COLLECTION

Pipeline Racks and Fixtures utilize 1-1/4" diameter plumbing pipe in Anthracite Gray finish. All racks include 3" casters, 2 locking and 2 non-locking. PSBB and PSBBADJ are also available in Gloss White.



**PSBB – Grey**  
**PSBBBW – White**  
64" high x 51" long  
x 23-3/8" wide

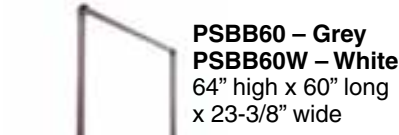

**PSBB60 – Grey**  
**PSBB60W – White**  
64" high x 60" long  
x 23-3/8" wide

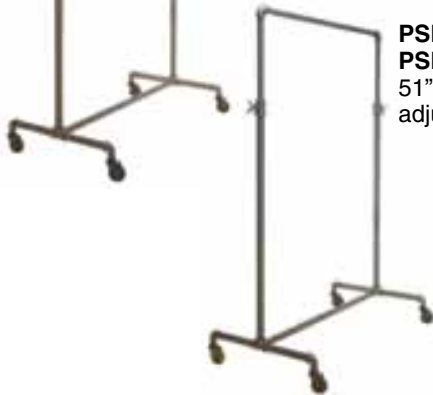

**PSBBADJ – Grey**  
**PSBBADJW – White**  
51" long x 23-3/8" wide x  
adjusts from 48"-72" high

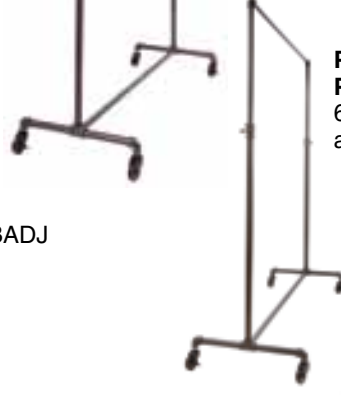

**PSBB60ADJ – Grey**  
**PSBB60ADJW – White**  
60" long x 23-3/8" wide x  
adjusts from 44"-72" high

**OPTIONAL**  
Hangbar to fit on PSBBADJ  
for double hanging.  
**PSAOH**



## PIPELINE OUTRIGGER SYSTEM

96" high, 1/2" slots on 1" centers. Includes mounting flanges and floor levelers. 1-1/4" diameter plumbing pipe in Anthracite Grey Finish. Outrigger stands 17-7/8" from wall. Price is for a set of 2 96" high posts.

**PSOR – Grey**



**PSBLLADJ – Grey**  
**PSBLLADJW – White**  
50" long x 29" wide,  
adjusts 50"-78" high.

## OPTIONAL HANGRAILS, FACEOUTS, SHELVING



**Faceout Bar**  
48" long with 2 - 12-3/4"  
faceouts for frontal display. Grey.  
**PSORFO48**



**Shelving**  
46-3/8" x 15-3/4" deep shelf in Black, Dk.  
Brown or White. Melamine Finish. Must use  
(PSORKB) brackets below. Special fitting.  
**PSORSLF48 – Black**  
**PSORSLF48DB – Dk Brown**  
**PSORSLF48W – White**



**Hangrails**  
24" or 48" long, Grey. Connect  
2 Outriggers, or 2 sets of  
Outriggers for continuous line.  
**HB24 – 24" Grey**  
**HB24W – 24" White**

*Pipeline collection includes 4-way racks,  
2-way racks and additional matching  
displays. Call for full catalog.*

**Brackets**  
Set of left and right bracket  
for shelving. Grey.  
**PSORKB**

**HB48 – 48" Grey**  
**HB48W – 48" White**

# PIPELINE FREE STANDING MERCHANDISER

Our pipeline merchandiser can be used anywhere in the store to create a stand alone vignette or as part of the full store Pipeline design. 94" high x 20" deep x 48" wide. Each of the four 1-1/4" diameter round uprights has 1/2" slots on 1" centers. May be merchandised to fit a variety of needs with any of our optional merchandising accessories, which include faceouts, handrails and shelving. Anthracite grey finish or glossy white.



## FREE STANDING MERCHANDISER

PSFS96 – Grey  
PSFS96W – White

### Merchandiser Utilizing Options



**12" Faceout Connector**  
Connects units together,  
24" long.  
**PSORFO24N – Grey**  
**PSORFO24NW – White**  
Minimum 2 pcs.

### Hangrails

24" long, Connects 2 units.  
**PSORHB24 – Grey**  
**PSORHB24W – White**

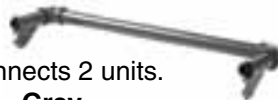

48" long, Connects 2 units  
or use on each merchandiser.  
**PSORHB48 – Grey**  
**PSORHB48W – White**



### OPTIONAL ADD-ONS



### 2-12" Faceout Displayers

Connect 2 units or use within merchandiser, 48" long.  
**PSORFO48N – Grey**  
**PSORFO48NWH – White**

# PIPELINE DISPLAY TABLES

Anthracite grey finish with dark brown melamine table top large nesting table, small nesting table and nesting topper.



**LARGE NESTING TABLE**  
62" long x 34" deep x 32" high.  
**PSNTLSET**



**SMALL NESTING TABLE**  
48" long x 24" deep x 24" high.  
**PSNTSSET**



**TOWER TABLE**  
14" long x 14" wide x 40" high.  
**PSITTSET**

*Pipeline collection includes 4-way racks, 2-way racks and additional matching displays. Call for full catalog.*

# WATERFALL DISPLAYERS

Polished chrome 3/4" square tubing. Use these sale makers throughout your store for full face display of bags and garments. Waterfalls can be combined for quantity pricing.

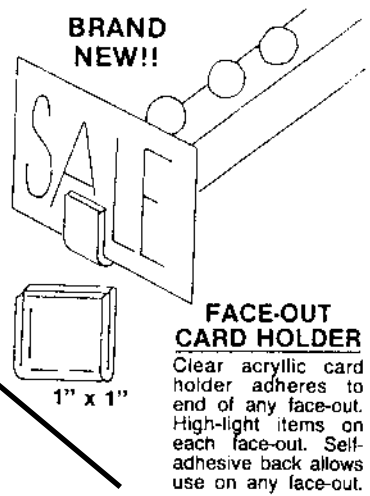
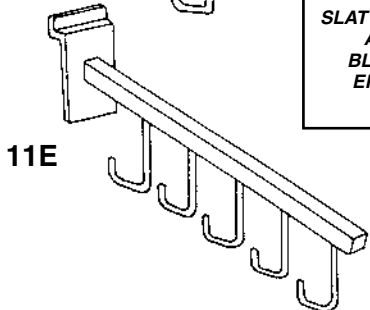
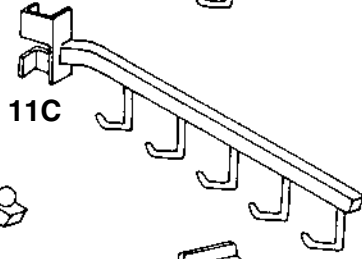
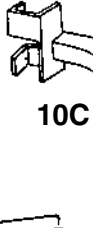
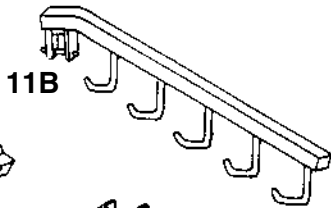
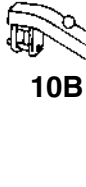
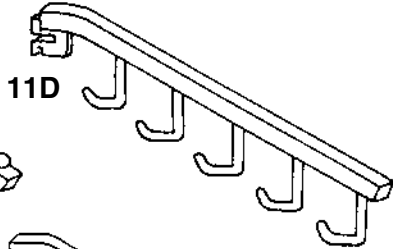
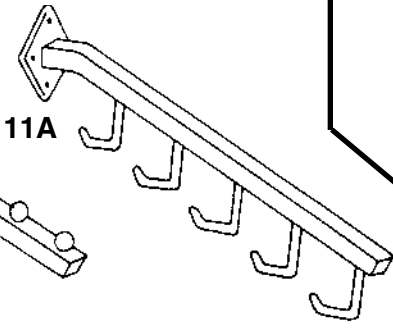
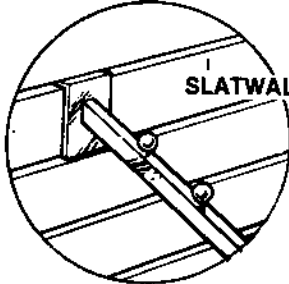
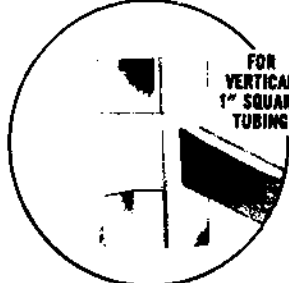
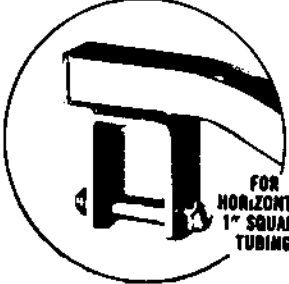
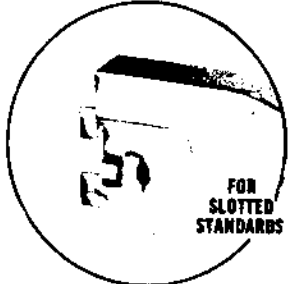

## FACE-OUT CARD HOLDER

Clear acrylic card holder adheres to end of any face-out. High-light items on each face-out. Self-adhesive back allows use on any face-out. (For blank cards see page 50.)

- M511 - Signholder
- \$ .25 ea.
  - \$ .20 ea. ( 50 Pcs.)
  - \$ .18 ea. (100 Pcs.)
  - \$ .15 ea. (500 Pcs.)

SLATWALL WATERFALL AVAILABLE IN BLACK OR WHITE EPOXY AS WELL AS CHROME

# STRAIGHT ARM DISPLAYERS

3/4" Square Tubing, Polished Chrome

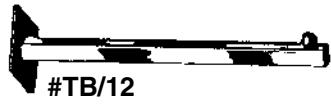

For wall mounting - 12"

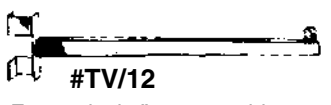

For vertical 1" square tubing - 12"

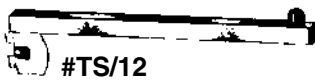

For slotted standard - 12"

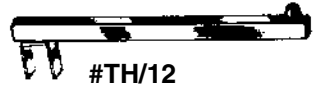

For horizontal 1" square tubing - 12"

# RECTANGULAR TUBING WATERFALL DISPLAYERS

Polished Chrome Displayers  
Made of 1/2" x 1 1/2" Tubing

All waterfalls are available in black or white finish at same prices listed below. Style numbers are for all chrome finish. If you want black or white finish, add B (for black) or W (for white) after style number.

## FOR WALL MOUNT (1/2"x1 1/2" Rectangular Tubing)

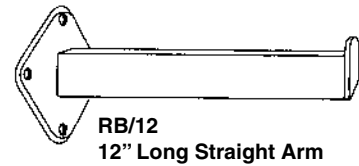
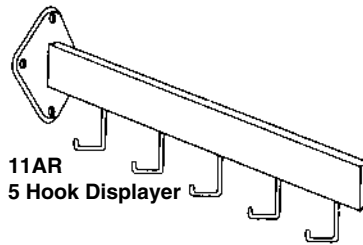
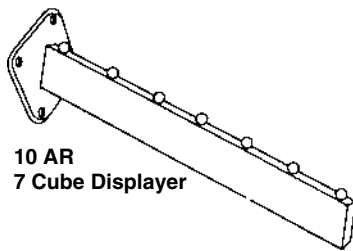

## FOR SLOTTED STANDARDS (1/2" Slot on 1" Centers)

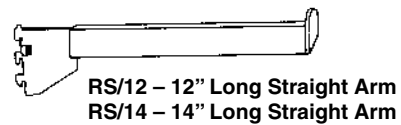
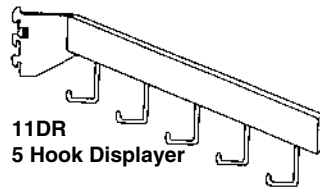
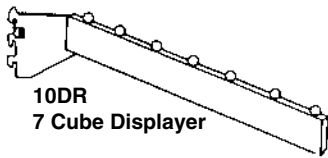

## FOR RECESSED OR HEAVY DUTY SLOTTED STANDARDS (1" Slots on 2" Centers)

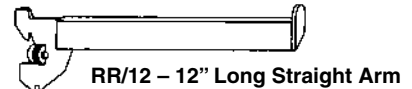
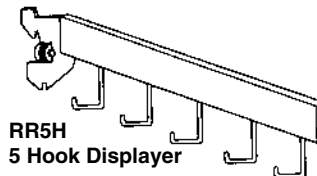
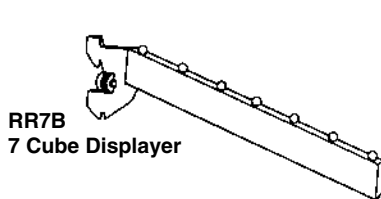

RR/14 - 14" Long Straight Arm

## FOR SLATWALL (1/2" x 1 1/2" Rectangular Tubing)

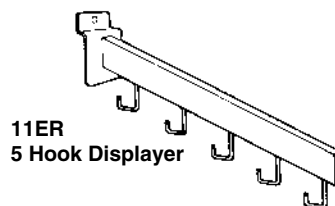
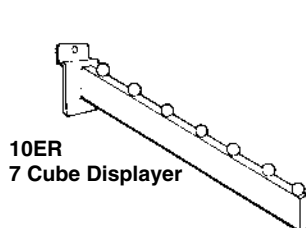

RW/3 - 3" Face Out  
RW/6 - 6" Face Out

## FOR GRIDWALL (1/2" x 1 1/2" Rectangular Tubing)

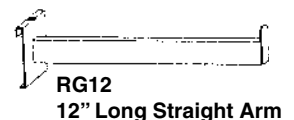
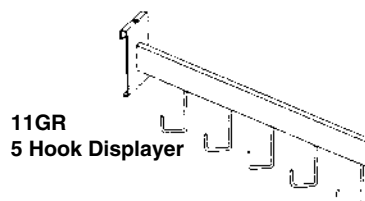
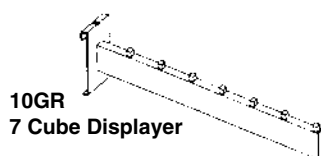

# MAGNETIC CLAMPS

For use with stems and card frames on page 49.

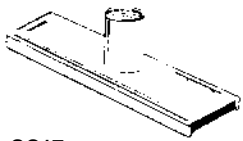

**SC17** – 3" long. Uses 3/8" or 1/4" fitting.



**SC18** – Magnetic side clamp for threaded stem.



**SC19** – Magnetic side clamp for swedged stem.

# THREADED OR SWEDGED STEMS

Use with any clamps.

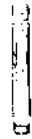

**M3** (3" long)  
**M6** (6" long)  
**M12** (12" long)



**SWEDGED STEMS**  
For use with SC19  
**NS3** – 3" long  
**NS6** – 6" long

## CLAMPS FOR USE WITH CARD FRAMES

**USE CC3 & OC1 CLAMPS ON** – 1" O.D. tubing or hangrails of the following fixtures:  
page 28 – 900, 903, page 30 – SWF, page 32 – SWF12, page 35 – 3LRR.

**USE CC4 & OC2 & SC22 CLAMPS ON** – 1-1/4" O.D. tubing or hangrails on the following fixtures:  
page 29 – GCR, Z60, Z60S, page 30 – SB, TS, page 32 – SQV, page 33, 34 – all racks, page 35 – R436, page 36 – K62, K43.

**USE SC5 CLAMPS WITH** – 1" square tubing on the support bars of the following fixtures:  
page 31 – all racks, page 32 – SQV, page 33 – SQDA, page 34 – all racks, page 35 – 3LRR36, 3LRR42, page 37 – all racks.

**USE SCM CLAMPS WITH** – 3/4" tubing, sides of vertical arms of the following fixtures:  
page 31 – all racks, page 32 – 2 way racks, page 37 – K13, K14.



**C CLAMPS WITH 2" NIPPLE**  
**CC3** - Fits 1" O.D. & 1-1/16" O.D. Tubing  
**CC4** - Fits 1-1/4" O.D. & 1-5/16" O.D. Tubing

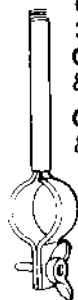

**O CLAMPS WITH 3" NIPPLES**  
**OC1** - Fits 1" O.D. & 1-1/16" O.D. Tubing  
**OC2** - Fits 1-1/4" O.D. & 1-5/16" O.D. Tubing

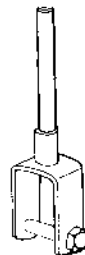

**SQUARE TUBE CLAMP**  
**SC5** Fits 1" square tube 3" nipple

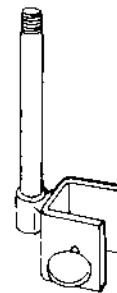

**SIDEMOUNT CLAMP WITH 3" STEM**  
**SCM** – fits 3/4" Tubing. For use with 4 way racks.

## MARKERBOARD A-FRAMES

Create and Change Powerful Sales Messages



- 36" high x 24" wide
  - Both sides
  - Black steel frame
  - Black or white panels
  - Bright, colorful markers
- 432BLK** – Black Markerboard  
**432WHT** – White Markerboard

### MARKERS

**For White Markerboard**  
**PMKWPK** – 5 chisel tip markers: blue, red, pink, black, green.

**For Black Markerboard**  
**PM5BPK** – 5 chisel tip markers: white, violet, yellow, pink.

## UNIVERSAL CLAMP

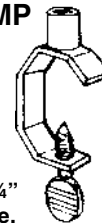

**SC22**  
Fits 1 & 1 1/4" Round Tube.  
1" square & 1/2" x 1 1/2" rectangular tubing.  
Uses threaded stems (on page 49).

**SC23** – Same as SC22 above but uses swedged stems (NS3 & NS6 on page 49).

## RECTANGULAR TUBE CLAMP

**SC6**  
Rectangular tubing clamp fits 1/2" x 1 1/2" tubing.

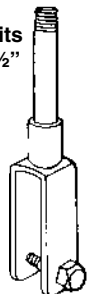



# CARD FRAMES INCREASE YOUR SALES

## FLAT BASE CARD HOLDER

Great for standing atop tables, counters, etc.; can be screwed into counters if so desired. Great for impulse sales. Beautiful chrome finish. Use these durable card holders throughout your store.

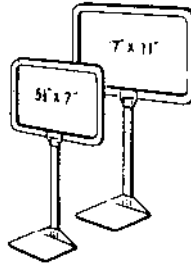

STYLE	SIZE	STEM HEIGHT
HFB57	5 1/2 high x 7 long	10"
HFB711	7 high x 11 long	10"

## CARD HOLDER

Uses 204D (4" base).

Adjustable height from 18" up to 36".

Choice of 3 sizes of card frames. Rounded Corner (page 48) or Mitered Corner, see below. Uses 204D (4" base).

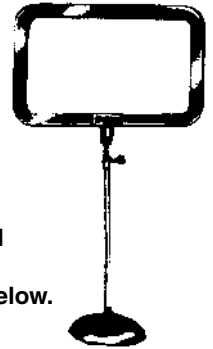

### Mitered Corner

- CH4 5 1/2" x 7" Frame
- CH5 7" x 11" Frame
- CH6 11" x 14" Frame

## CLEAR ACRYLIC CARD HOLDERS

### Chrome Channel with Receptor

Acrylic Card Holder with chrome channel (3/8" fitting).

PJ57 – 5-1/2" H x 7" W (Uses Size A Cards)

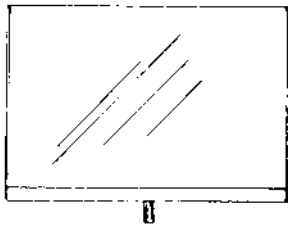

PJ711 – 7" H x 11" W (Uses Size B Cards)

PJ811 – 8-1/2" W x 11" H

PJ811V – 8-1/2" H x 11" W

## MITERED CORNER CARD HOLDERS

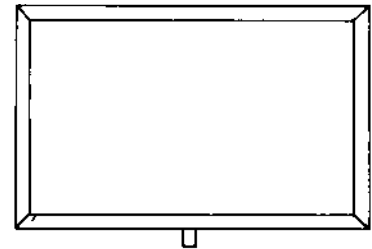

Beautifully crafted welded chrome card frames in three sizes. 3/8" fitting

MF57 – 5 1/2" x 7" long

MF711 – 7" high x 11" long

MF114 – 11" high x 14" long



**CF711**  
7" High x 11" Long  
Use size B card  
on page 50

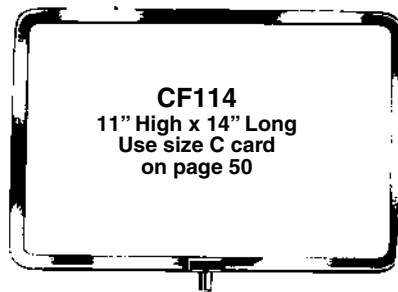

**CF114**  
11" High x 14" Long  
Use size C card  
on page 50

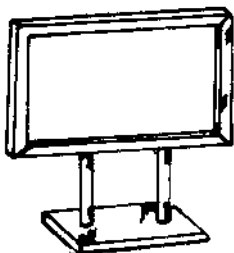

## DOUBLE POST ALL CHROME CARD FRAME

Beautiful all chrome plated card frame. Heavy rectangular base connects to card frame by two 4" posts.

- MCP57 – 5-1/2" H x 7" W Frame
- MCP711 – 7" H x 11" W Frame
- MCP114 – 14" H x 11" W Frame

# BULLETIN SIGN HOLDERS

**GREAT FOR INTRODUCING SALES & SPECIALS!**  
SIGNHOLDERS ARE AVAILABLE IN CHROME OR MATTE BLACK!

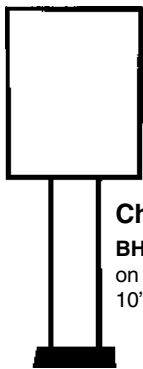

## Chrome Finish

**BHB28** – 22" x 28" sign frame on 2-31" high round uprights. 10" x 14" heavy base. 59" high.

**BHB22** – 14" x 22" sign frame base & upright same as above. 53" high.

## Matte Black Finish

**BHB28MAB** – 22" x 28" sign frame on 2-31" high round uprights. 10" x 14" heavy base. 59" high.

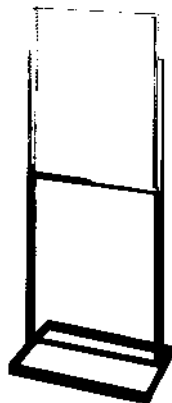

## Chrome Finish

**BHB30** – 22" x 28" sign frame uprights & frame base are rectangular tubing. 15" x 24" base. 56" high.

**BHB24** – 14" x 22" sign frame uprights & frame base are rectangular tubing. 12" x 26" base. 56" high.

## Matte Black Finish

**BHB30MAB** – Same as BHB30 but with matte black epoxy finish.



## Triple Sign Holder

**BHB77** – Chrome 22" x 28" holders. Rectangular tubing base 24" x 25". 90" high.

**BHB77MAB** – Matte black finish. Description same as above but has a matte black epoxy finish.

## Double Sign Holder

**BHB55** – Chrome. 22" x 28". 60" high.

**BHB55MAB** – Matte black. 22" x 28". 60" high.

# CRYSTAL CLEAR SIGNHOLDERS

MADE OF DURABLE CYRO HP MULTIPOLYMER SHEET

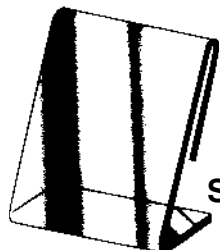

## SLANTBACK SINGLE SIGN SIGNHOLDERS

### Horizontal Signholders

**CT57HSB** – 5 1/2" H x 7" wide  
**CT711HSB** – 7" H x 11" wide

### Vertical Signholders

**CT57VSB** – 7" H x 5 1/2" wide  
**CT811VSB** – 11" H x 8 1/2" wide

**CT811VSBP** – 11" H x 8 1/2" wide, has a 4" pocket built into lower right side of sign frame.

## BOTTOM LOAD SIGNHOLDERS FOR DOUBLE SIDED SIGNAGE

### Horizontal Signholders

**CT57H** – 5 1/2" H x 7" wide  
**CT711H** – 7" H x 11" wide  
**CT811H** – 8 1/2" H x 11" wide  
**CT114H** – 11" H x 14" wide

### Vertical Signholders

**CT57V** – 7" H x 5 1/2" wide  
**CT711V** – 11" H x 7" wide  
**CT811V** – 11" H x 8 1/2" wide  
**CT114V** – 14" H x 11" wide

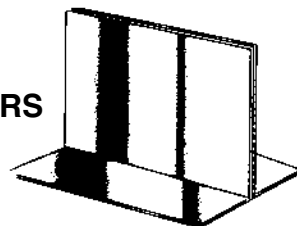

# CARDS

To trigger more sales. These cards fit into the above cardholders to promote specials. Spread them throughout your store. Fluorescent orange and blue or neon green on sturdy white stock. Four styles to choose from. Prices are per 100.

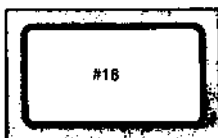

#18 BLANK WITH ORANGE BORDER

#19 SPECIAL

#22 SALE

#34 REDUCED

#36 AS ADVERTISED

SAMPLE ORDER:

100 #A19

(100 5-1/2" x 7" Special)

Size A 5-1/2" high x 7" wide

Size B 7" high x 11" wide

Size C 11" high x 14" wide

## BLANK WHITE CARDS

Size A 5-1/2" high x 7" wide

Size B 7" high x 11" wide

# INFORMATIVE WINDOW SIGNAGE

Heavy Duty Plastic Material



**PS107**  
Front/Back



**PS106**  
Front/Back



**PS104**  
Front/Back

# SLATWALL MERCHANDISING SYSTEM

*The Most Versatile Display System Ever Created! Slatwall Hardware can be moved easily and quickly to change the look of your store!!*

American minimizes your shipping charges by shipping Slatwall products from eight different factories throughout the United States. Our factories are located in Georgia, California, Virginia, Connecticut, Washington, Ohio, North Carolina, and New York. You can pick up or we will deliver from the nearest plant or from New Jersey, so your shipping charges will be minimal. Orders shipped FOB N.J. or nearest factory. Pricing on Slatwall may vary for local pick up or delivery in N.Y. and N.J. Call for local pick up.

## WOOD SLATWALL PANELS

48" High x 96" Wide x 3/4" Thick, MDF Board

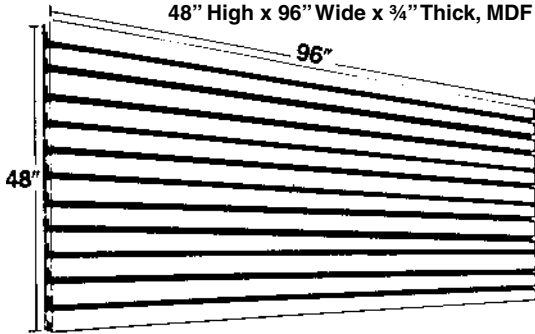

(shown above) Horizontal – 16 grooves, 3" apart

Also Available (not shown)

Horizontal – 8 grooves, 6" apart

Vertical – 32 grooves, 3" apart

Vertical – 16 grooves, 6" apart

SLP96 Ready to Paint Fiberboard

FLP96 LDL melamine finish, white, grey, almond, black. Wood grains: pear wood, beech, mahogany, cherry, maple.

FLP96B Brushed aluminum melamine

ALP96R Red oak veneer (1/8" thick finish)

ALP96M Maple veneer (1/8" thick finish)

MIC96 Formica brand finish, any color (high density laminated)

MPL96 Acrylic mirror finish

Aluminum Inserts – Grooves 3" apart

Plastic Inserts – Grooves 3" apart

## ALL CHROME SLATWALL HARDWARE

### SQUARE TUBING WATERFALLS CHROME WATERFALLS

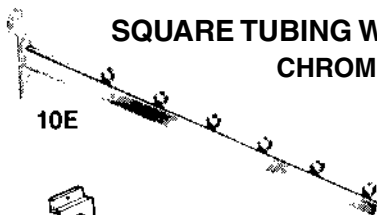

10E

10E – 6 Ball Waterfall  
3/4" Square Tubing

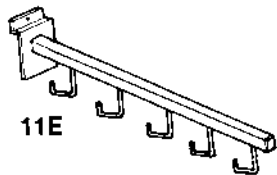

11E

11E – 5 Hook Waterfall

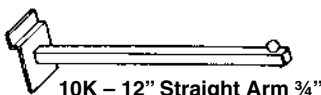

10K – 12" Straight Arm 3/4"

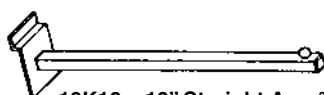

10K16 – 16" Straight Arm 3/4"

All hardware this page is available in black or white epoxy finish at the same price. Style numbers are for chrome finish. Indicate B (for black) or W (for white) after style number below.

### CHROME DISPLAY HOOKS 1/4" THICK

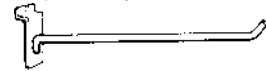

DH1 1" Long  
DH4 4" Long  
DH6 6" Long  
DH8 8" Long  
DH10 10" Long  
DH12 12" Long

Above brackets are also available in Black and White

### HANGRAIL BRACKET

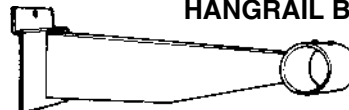

SUY 10A – 12" Long Hangrail, Bracket for 1" Round Tubing  
SUY 10B – 12" Long Hangrail, Bracket for 1 1/4" Round Tubing

### SHOE SHELVES



PX410 – 4"x10" wide shelf,  
1/8" thick

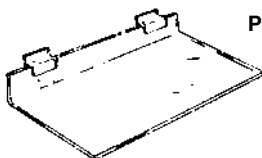

PX612 – 6"x12" wide shelf, 1/8" thick

PX612 has a double angled insert.



Shoe Shelf With Sign Slot  
PX410SL – 4"x10" wide

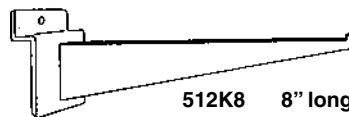

### SHELF BRACKET

512K8 8" long  
512K10 10" long  
512K12 12" long  
512K14 14" long  
512K16 16" long

Above brackets are also available in Black and White.  
Call for price.

### RECTANGULAR TUBING BRACKET

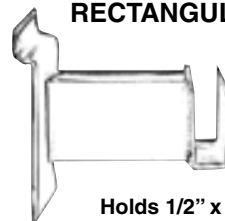

SW/FB – 12" Long Bracket

SW/R2 – 3" Long Bracket

Holds 1/2" x 1-1/2" Rectangular Tubing.  
See page 66

# FREE STANDING SLATWALL DISPLAYERS



**Rotating Units**  
CUB48  
CUB20



**Rotating**

20" x 20" x 60" high  
CUB20W - White  
CUB20M - Maple  
CUB20B - Black  
CUB20C - Cherry



**4-Way**

**Non-rotating**

24" x 24" x 54" high  
CUB60W - White  
CUB60M - Maple  
CUB60B - Black  
CUB60C - Cherry



**I Unit**

36" x 36" x 54" high  
4WAYW - White  
4WAYM - Maple  
4WAYB - Black  
4WAYC - Cherry

49-1/2" x 24" x 54" high  
IUNITW - White  
IUNITM - Maple  
IUNITB - Black  
IUNITC - Cherry

**Rotating**  
12" x 12" x 54" high  
CUB48W - White  
CUB48M - Maple  
CUB48B - Black  
CUB48C - Cherry

*Bring the Slatwall look to your selling floor! These displayers are constructed of heavy duty wood. Slats are every 3". Displayers are perfect for socks, shoes, hosiery, underwear, and accessories. Cube unit comes 2 sizes. Available in white, black, maple finish, or cherry finish.*

Unit	Color	Specifications
CUB48W	White	12" x 12" x 54" High
CUB48M	Maple	12" x 12" x 54" High
CUB48B	Black	12" x 12" x 54" High
CUB48C	Cherry	12" x 12" x 54" High
CUB20W	White	20" x 20" x 60" High
CUB20M	Maple	20" x 20" x 60" High
CUB20B	Black	20" x 20" x 60" High
CUB20C	Cherry	20" x 20" x 60" High
CUB60W	White	24" x 24" x 54" High
CUB60M	Maple	24" x 24" x 54" High
CUB60B	Black	24" x 24" x 54" High
CUB60C	Cherry	24" x 24" x 54" High
4WAYW	White	36" x 36" x 54" High
4WAYM	Maple	36" x 36" x 54" High
4WAYB	Black	36" x 36" x 54" High
4WAYC	Cherry	36" x 36" x 54" High
IUNITW	White	49-1/2" x 24" x 54" High
IUNITM	Maple	49-1/2" x 24" x 54" High
IUNITB	Black	49-1/2" x 24" x 54" High
IUNITC	Cherry	49-1/2" x 24" x 54" High

## SLATWALL HANGRAILS

Round Tubing "U" Shaped Hangrail



\* made with 1/4" chrome wire on top of tubing

SW681/C - Chrome  
SW681/B - Black Epoxy\*  
SW681/W - White Epoxy\*

Rectangular Tubing  
U Shaped Hangrails  
Available at  
Same Price.  
(Add R to Style #)

## SLATWALL MILLINERY HAT DISPLAYER

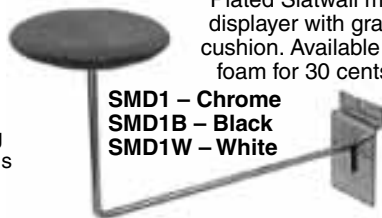

Plated Slatwall millinery displayer with gray foam cushion. Available without foam for 30 cents less.

SMD1 - Chrome  
SMD1B - Black  
SMD1W - White

## SLATWALL SCARECROW



Adjustable displayer with gray foam in width from 20"-35"

SW/T - Chrome  
EBL/T - Black  
EWH/T - White

## SLATWALL AND GRIDWALL SIGNHOLDERS

New design fitting allows you to interchange these signholders on either Gridwall or Slatwall. Made of crystal clear thermoplastic. Brand new! 8 1/2" x 11" size for computer generated signage.



**Horizontal**  
SG57H 5 1/2" high 7" wide  
SG711H 7" high 11" wide  
SG811H 8 1/2" high 11" wide

**Vertical**  
SG57V 7" high 5 1/2" wide  
SG711V 11" high 7" wide  
SG811V 11" high 8 1/2" wide  
SG114V 14" high 11" wide

# SLATWALL DISPLAYERS

## Clear Acrylic Slatwall Displayers

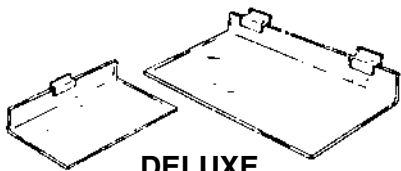

### DELUXE SLATWALL SHELVES

1/4" for extra support.  
For economy models see page 51.

- 2007 – 8" W x 12" L
- 2009 – 8" W x 16" L
- 2011 – 8" W x 24" L
- 2013 – 12" W x 16" L

### SLATWALL DISPLAY TRAYS

(2" Deep)

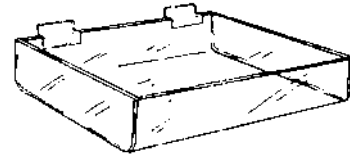

- 2210 – 4" W x 8" L
- 2214 – 4" W x 12" L
- 2218 – 8" W x 12" L
- 2222 – 8" W x 16" L

### SLATWALL SINGLE AND DOUBLE HOSIERY BINS

Holds 7" wide packaged hose.

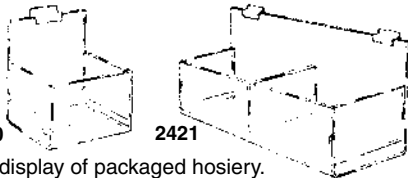

2420

2421

Great for display of packaged hosiery.

2420 – Single Hosiery Holder  
8" W x 7" H x 5" D

2421 – Double Hosiery Holder  
16" W x 7" H x 5" D

### EARRING LADDER DISPLAY

4-1/2" long x 3" wide rungs.

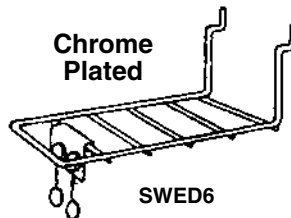

Chrome  
Plated

SWED6

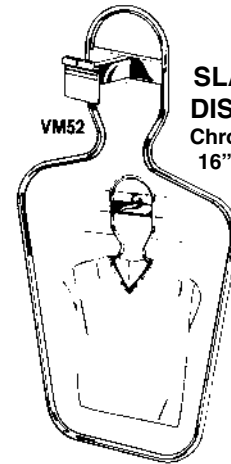

SLATWALL  
DISPLAYER  
Chrome Plated  
16" Displayer

VM52

## CAP & HAT DISPLAYERS

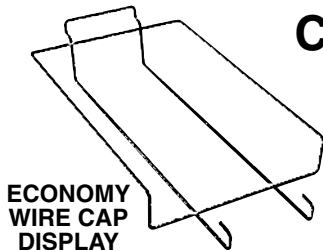

ECONOMY  
WIRE CAP  
DISPLAY

ECCAPW – White  
ECCAPB – Black  
ECCAPC – Chrome

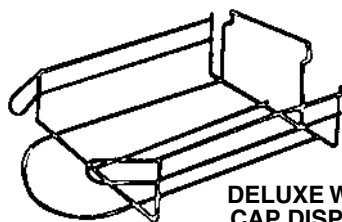

DELUXE WIRE  
CAP DISPLAY

CAPW – White  
CAPB – Black

CAPC – Chrome

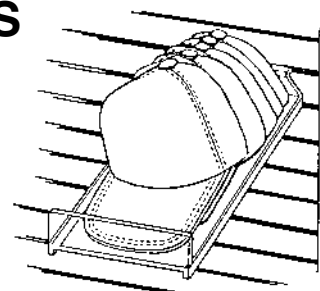

1762 – CLEAR  
PLASTIC CAP  
DISPLAYER

6-1/2" wide x 12"  
long with 1-1/2" lip.  
Down-slants at a 10  
degree angle for a  
better visual display.  
For one-six hats.  
Polystyrene.

1762

## SHOE, SLIPPER & SNEAKER DISPLAYERS

### ADJUSTABLE SHOE DISPLAY

Versatile. Adjusts into 5 different  
positions. 3/16" acrylic.

JH22 – Toe Rest  
JH24 – Heel Rest

JH22  
Toe  
Rest

JH24  
Heel  
Rest

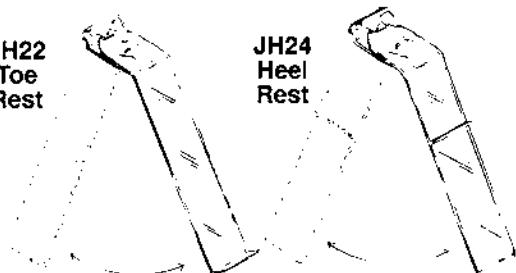

### POLYCARBONATE CRYSTAL CLEAR SHOE RESTS

#### Swivel Shoe Rests

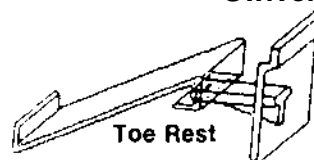

Toe Rest

Swivel Toe Rest Adjusts  
to Face Left or Right

PT310

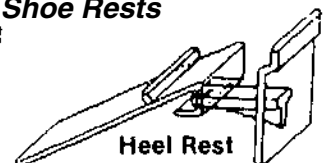

Heel Rest

Swivel Heel Rest Adjusts  
to Face Left or Right

PH310





# SLATGRID PANELS

Available in Chrome, Black or White. Versatile display panels that can use any Slatwall or Gridwall hardware (pages 51-53, 55-58). Panels are 24" wide by 48", 60", 72", 84", & 96" high. 48" x 48" panels are also available. Shipped UPS except for 24" x 84", 24" x 96", & 48" x 48", which are shipped by truck.

Black	White	Description
STG448B	STG448W	24" wide x 48" high
STG460B	STG460W	24" wide x 60" high
STG472B	STG472W	24" wide x 72" high
STG484B	STG484W	24" wide x 84" high
STG496B	STG496W	24" wide x 96" high
STG4848B	STG4848W	48" wide x 48" high

Chrome	Description
STG448	24" wide x 48" high
STG460	24" wide x 60" high
STG472	24" wide x 72" high
STG484	24" wide x 84" high
STG496	24" wide x 96" high
STG4848	48" wide x 48" high

Panels are packed 3 per box.

## PERIMETER WALL SYSTEMS

Choice of 3 outriggers to modernize your store.  
Screw outriggers into wall every 4, 5, or 6 ft.  
Combine with hangrails & shelving for greater utility.  
These units put all of the weight on your floor.

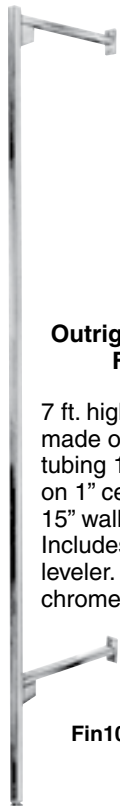
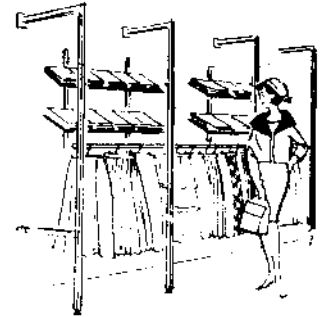

**Outrigger Wall Unit  
Fin100C**

7 ft. high. Upright made of 1" square tubing 1/2" slots are on 1" centers. Two 15" wall supports. Includes adjustable leveler. Polished chrome.



**Deluxe  
Outrigger Wall Unit  
F200C**

87" in height. Made of 1" x 2" rectangular tubing. 15" rectangular tubing wall supports. Includes adjustable leveler. Polished chrome.

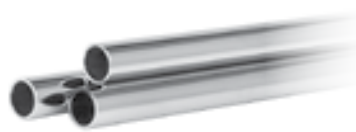

**HEAVY WALL 1" O.D.  
CHROME TUBING**

TBE48 1" dia. x 4 ft  
TBE60 1" dia. x 5 ft  
TBE72 1" dia. x 6 ft

**HEAVY WALL 1-1/4" O.D.  
CHROME TUBING**

SBE48 1-1/4" dia. x 4 ft  
SBE60 1-1/4" dia. x 5 ft.  
SBE72 1-1/4" dia. x 6 ft.

**LOWER PRICES IN QUANTITY  
SEE PAGE 63**

**HANG ROD  
BRACKET**

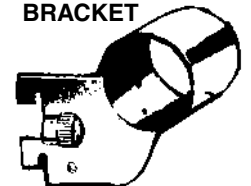

5632 A - For 1" Dia. Tube  
5632 B - For 1-1/4" Dia.

### STRAIGHT ARM - ADD ON TO OUTRIGGERS

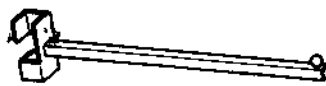

TV/16  
16" chrome straight arm made of 3/4" square tubing.

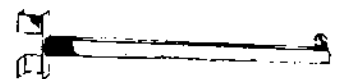

TV/12  
12" chrome straight arm made of 3/4" square tubing.

# GRIDWALL DISPLAY SYSTEM

Available in All Chrome, Black Epoxy or White Epoxy Finish

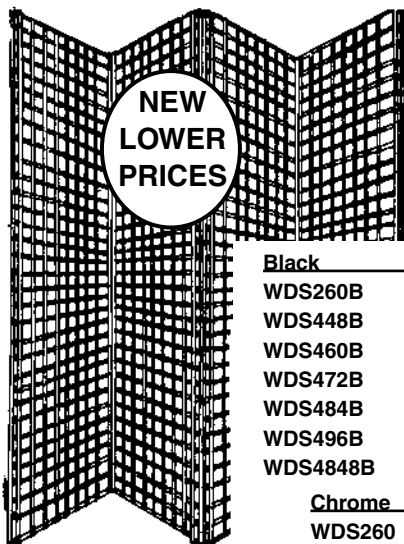

Grids are packed 3 per carton.

Wire Display System is constructed of 3/16" diameter internal horizontal and vertical wire, creating 3" square sections. The outside double edge wires are constructed of 1/4" diameter wire for added stability. All panels are easily joined together with chrome connectors to form many different configurations. Panels can also be hung on wall by using wall brackets illustrated below.

All panels are 24" wide, except for WDS4848 which is 48"x48" wide and WDS260 which is 12" wide. Grids can be shipped UPS except for 24" x 84", 24" x 96", & 48" x 48", which are shipped by truck.

## GRID PANELS

Black	White	Description
WDS260B	WDS260W	12" wide x 60" high
WDS448B	WDS448W	24" wide x 48" high
WDS460B	WDS460W	24" wide x 60" high
WDS472B	WDS472W	24" wide x 72" high
WDS484B	WDS484W	24" wide x 84" high
WDS496B	WDS496W	24" wide x 96" high
WDS4848B	WDS4848W	48" wide x 48" high

Chrome	Description
WDS260	12" wide x 60" high
WDS448	24" wide x 48" high
WDS460	24" wide x 60" high
WDS472	24" wide x 72" high
WDS484	24" wide x 84" high
WDS496	24" wide x 96" high
WDS4848	48" wide x 48" high

## GRIDWALL HARDWARE

All hardware is also available in black or white epoxy finish. At the same prices listed below. Style numbers are for all chrome finish. If you want black or white finish, indicate B (for black) or W (for white) after style number.

### SHELF BRACKET



GW12KB - 12" long  
GW14KB - 14" long

### HANGRAIL BRACKET



12" Long

GW12A1 -  
For 1 Dia. Tubing  
GW12B1 -  
For 1 1/4" Dia. Tubing

### WATERFALLS



10GW - 7 Balls  
3/4" Square Tubing

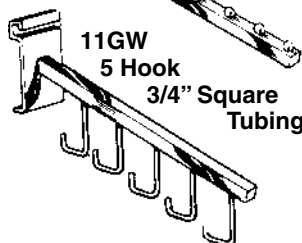

11GW  
5 Hook  
3/4" Square Tubing



### FACE OUT

12" long, 3/4" square tubing  
GW12



### 12" LONG BRACKET

For Rectangular Tubing 1/2" x 1-1/2"

GW/FB

**NEW  
LOWER  
PRICES**



### GRID HOOK

1/4" Dia. All Chrome

GW4 - 4"  
GW6 - 6"  
GW8 - 8"  
GW10 - 10"  
GW12A - 12"

### WALL BRACKET



WB



### GRID CONNECTOR

GC

### GRIDLEGS

24" Rectangular Tubing Legs

GL24 - Chrome  
GL24B - Black  
GL24W - White

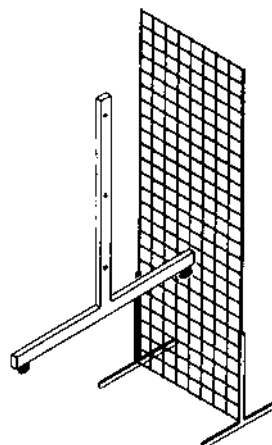

# GRIDWALL ACCESSORIES

**FLAT SHELF  
GWS/93**

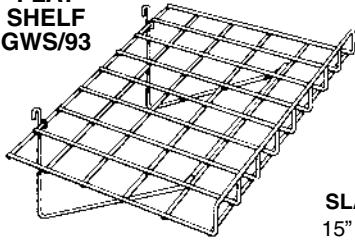

**FLAT SHELF WITH LIP**  
15" x 24" – Great for sweater  
or flat goods display.

BLKS/93 – Black  
WTES/93 – White      GWS/93 – Chrome

**SLANT SHELF  
GWS/91**

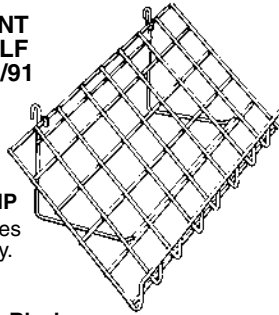

**SLANT SHELF WITH LIP**  
15" x 24" – Great for shoes  
or for full product display.

BLKS/91 – Black  
WTES/91 – White      GWS/91 – Chrome

**BASKET  
GWS/92**

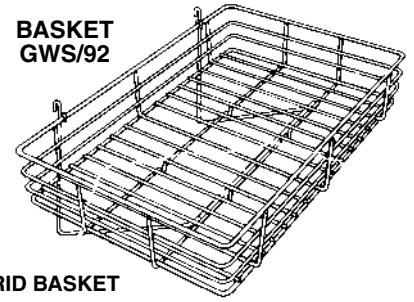

**GRID BASKET**  
15" x 24" – Great for multi-  
purpose product display.

BLKS/92 – Black  
WTES/92 – White)      GWS/92 – Chrome

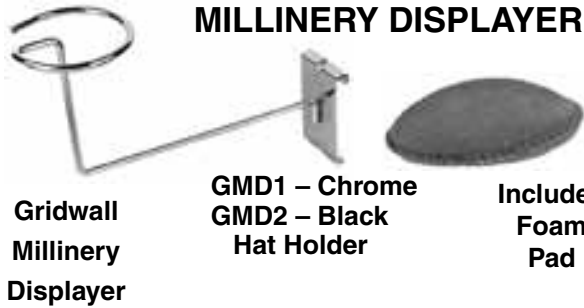

**MILLINERY DISPLAYER**

GMD1 – Chrome  
GMD2 – Black  
Hat Holder

Includes  
Foam  
Pad

Gridwall  
Millinery  
Displayer

**GRID SHOE SHELF  
CLEAR PLASTIC**



GX410 - 4"x10"

## CAP HOLDERS

**ECONOMY  
WIRE  
CAP DISPLAY**  
Holds 9 caps

WTE/ECCAP – White  
BLK/ECCAP – Black

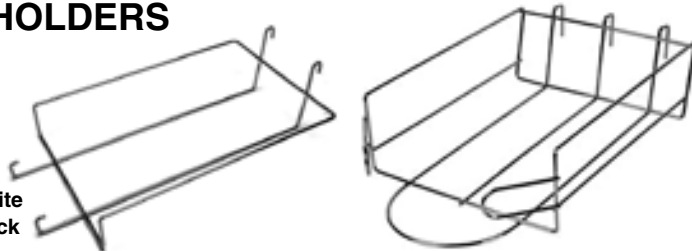

**DELUXE WIRE CAP HOLDER**

WTE/CAP – White      GW/CAP – Chrome  
BLK/CAP – Black

GW/ECCAP – Chrome

## GRIDWALL SCARECROW

Adjustable from 20"–35" wide

GW/T – Chrome  
BLK/T – Black  
WTE/T – White

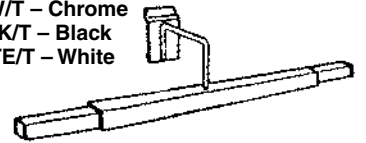

## GRIDWALL HANGRAILS

Create an effective display with these versatile hangrails.



**QUARTER CIRCLE HANGRAIL**

KHG680 – Chrome  
BLHG680 – Black  
WTHG680 – White

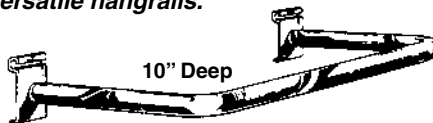

**"U" SHAPED HANGRAIL**

KHG681 – Chrome  
BLHG681 – Black  
WTHG681 – White

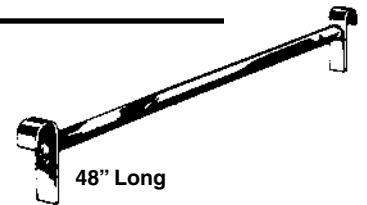

**STRAIGHT HANGRAIL 1-1/4" TUBING**

KHG684 – Chrome  
BLK684 – Black

White & Black epoxy hangrails have chrome wire on top of hangrail, for easy glide.

# GRIDWALL SHELVES

1/8" wire in black, white, & chrome.

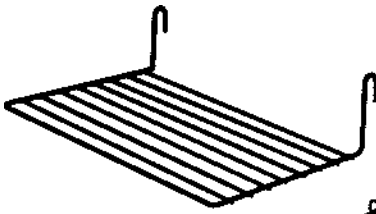

**STRAIGHT SHELF**  
8" deep x 12" wide  
BLK/812 – Black

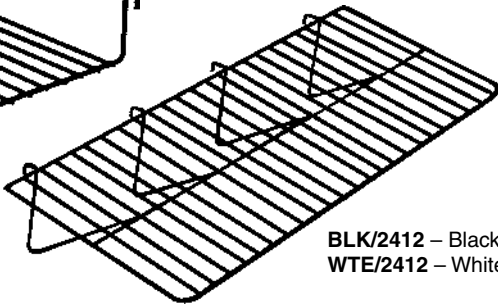

BLK/2412 – Black  
WTE/2412 – White

**STRAIGHT SHELF**  
12" deep x 23-1/2" wide

EC/2412 – Chrome

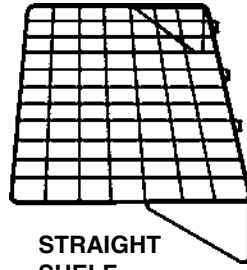

**STRAIGHT SHELF**  
14" deep x 23-1/2" wide  
BLK/2314 – Black  
WTE/2314 – White

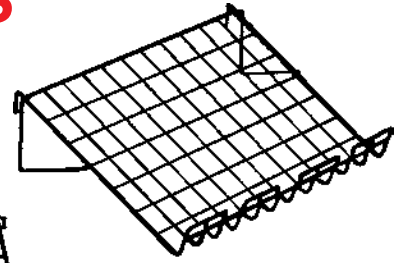

**SLANT SHELF**  
14" deep x 22-1/2" wide  
with 3" lip.  
BLK/SL22 – Black  
WTE/SL22 – White  
EC/SL22 – Chrome

# ALL-PURPOSE BASKETS

*Fits Slatwall, Gridwall and Pegboard*

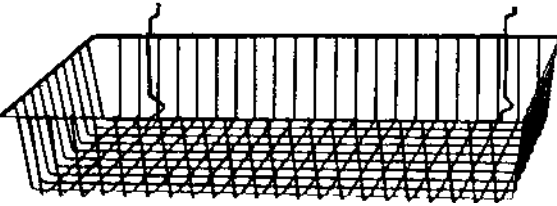

**SHALLOW BASKET**  
24" W x 12" D x 4" H  
BSK11/B – Black  
BSK11/W – White  
BSK11/EC – Epoxy Chrome  
FCB11/EC – Silver Grey

**NEW  
LOWER  
PRICES!**



**DEEP BASKET**  
12" W x 12" D x 8" H  
BSK15/B – Black  
BSK15/W – White  
BSK15/EC – Epoxy Chrome

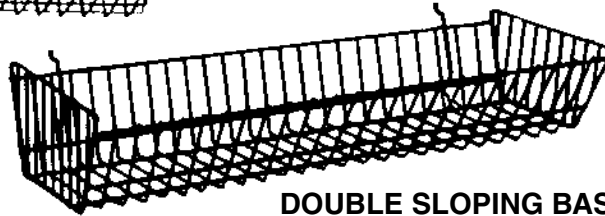

**DOUBLE SLOPING BASKET**  
24" W x 10" D x 5" H  
BSK12/B – Black  
BSK12/W – White  
BSK12/EC – Epoxy Chrome

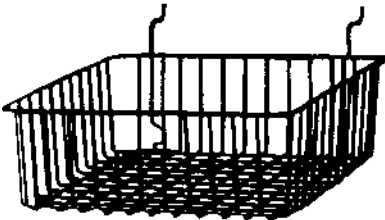

**SMALL BASKET**  
12" W x 12" D x 4" H  
BSK13/B – Black  
BSK13/W – White  
BSK13/EC – Epoxy Chrome

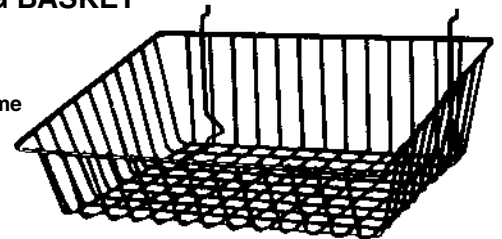

**SLOPING BASKET**  
15" W x 12" D x 5" high in back  
and 3" high in front.  
BSK16/B – Black  
BSK16/W – White  
BSK16/EC – Epoxy Chrome

**Fits  
slatwall, Gridwall  
and Pegboard!**

## SLOPED FRONT BASKET

12" W x 12" D x 8" high in  
back and 4" high in front.  
BSK14/B – Black  
BSK14/W – White  
BSK14/EC – Epoxy Chrome

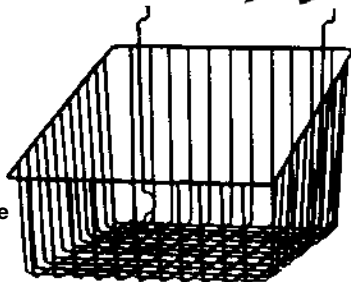

## NARROW BASKET

12" W x 6" D x 6" H  
BSK17/B – Black  
BSK17/W – White  
BSK17/EP – Epoxy Chrome



# GRID HARDWARE

## CLEAR ACRYLIC GRIDWALL DISPLAYERS

*Heavy-duty acrylic that will last forever*

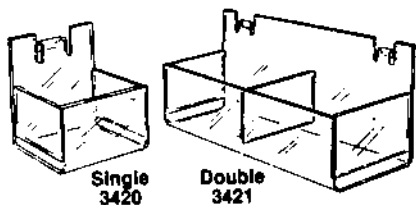

### GRIDWALL SINGLE AND DOUBLE HOSIERY BINS

Great for display of packaged hosiery!!  
(Holds 7" wide packaged hose.)

**3420** – Single Hose Holder  
8" W x 7" H x 5" D

**3421** – Double Hose Holder  
16" W x 7" H x 5" D

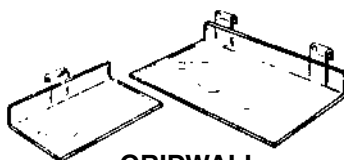

### GRIDWALL FLAT SHELVES

Sturdy 1/4" thick clear acrylic  
**3006** – 6" W x 12" L

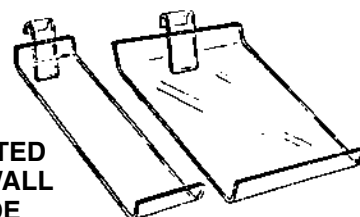

### SLANTED GRIDWALL SHOE FACEOUTS

3" and 7" wide x 10" long.

**3085** – Single Width  
3" W x 10" L (toe)

**3087** – Double Width  
7" W x 10" L (toe)

### GRIDWALL DISPLAY TRAYS

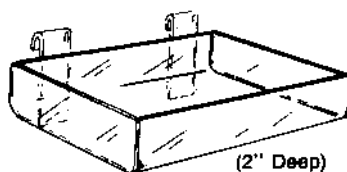

- 3210** – 4" wide x 8" long
- 3214** – 4" wide x 12" long
- 3218** – 8" wide x 12" long
- 3222** – 8" wide x 16" long

### TUBULAR GRIDWALL DISPLAYER

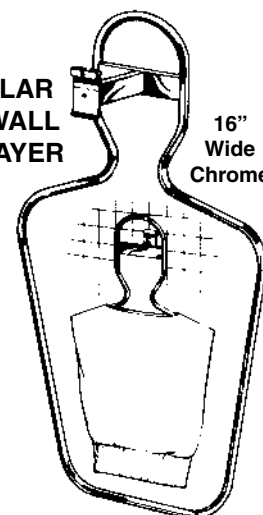

VM51

16" Wide  
Chrome

## GRIDWALL BASES

Create your own display racks with these gridwall bases. Each style base is available in chrome, black or white. The 4-way & triangle base are on wheels, the gondola is not. Use any grid from pages 54 & 55 and create your own display racks. Choose 48", 60", 72", 84" or 96" high grid in chrome, black or white.

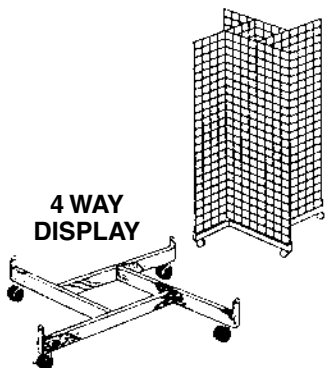

### 4 WAY DISPLAY

### 4 WAY GRID BASE

GW/4BA – Chrome

BLK/4BA – Black

WTE/4BA – White

Base comes with wheels

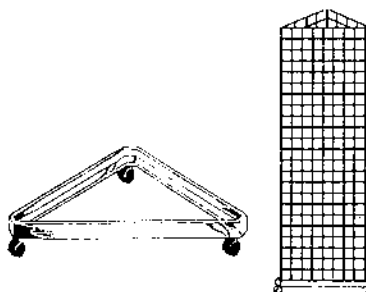

### TRIANGLE BASE

GW/3TB – Chrome

BLK/3TB – Black

WTE/3TB – White

Base comes with wheels

### GONDOLA USES 4 GRID PANELS

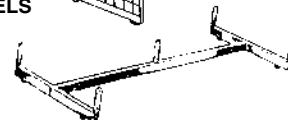

### GONDOLA BASE

GW/G15 – Chrome

BLK/G25 – Black

WTE/G48 – White

**PRICES ARE FOR BASES ONLY**



# GLASS SHIRT CUBES

## OUR MOST POPULAR GLASS CUBIE UNITS

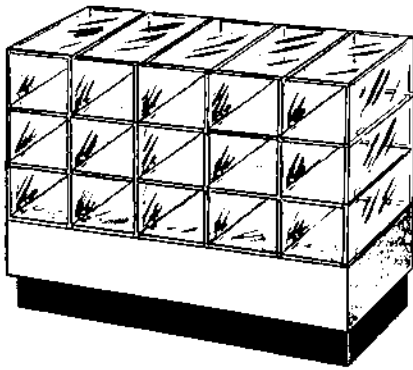

Units use 3/16" thick tempered glass and chrome metal connectors. All parts included with each unit.

**Cube A** uses 16" x 10" glass, for shirts or pants etc.

**Cube B** uses 12" x 12" glass, for sweaters and bulky items.

Closed back units will include 10" x 10" glass for Cube A and 12" x 12" glass for Cube B.

### TWO SIZE CUBES TO CHOOSE FROM

**Cube A:** 16" deep x 10" high x 10" wide

**Cube B:** 12" deep x 12" high x 12" wide

Choice of open or closed back.

### COMPONENT PARTS

Individual glass, Lexan clips or chrome metal clips can be purchased separately to create your own display.

## GLASS CUBE UNITS

3/16" Tempered Glass

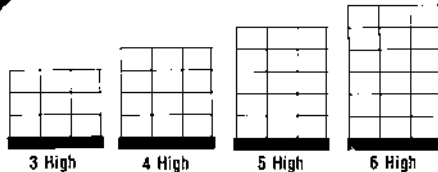

### OPEN BACK

3 HIGH X	Cube A	Cube B
3 Wide	AT33	BT33
4 Wide	AT34	BT34
5 Wide	AT35	BT35
6 Wide	AT36	BT36

### CLOSED BACK

Cube A	Cube B
ACT33	BCT33
ACT34	BCT34
ACT35	BCT35
ACT36	BCT36

4 HIGH X	Cube A	Cube B
3 Wide	AT43	BT43
4 Wide	AT44	BT44
5 Wide	AT45	BT45
6 Wide	AT46	BT46

Cube A	Cube B
ACT43	BCT43
ACT44	BCT44
ACT45	BCT45
ACT46	BCT46

5 HIGH X	Cube A	Cube B
3 Wide	AT53	BT53
4 Wide	AT54	BT54
5 Wide	AT55	BT55
6 Wide	AT56	BT56

Cube A	Cube B
ACT53	BCT53
ACT54	BCT54
ACT55	BCT55
ACT56	BCT56

6 HIGH X	Cube A	Cube B
3 Wide	AT63	BT63
4 Wide	AT64	BT64
5 Wide	AT65	BT65
6 Wide	AT66	BT66

Cube A	Cube B
ACT63	BCT63
ACT64	BCT64
ACT65	BCT65
ACT66	BCT66

ALL PRICES ABOVE INCLUDE ALL GLASS AND CHROME METAL CONNECTORS TO FORM UNIT.

Lexan connectors can be substituted for metal connectors if wanted.

For wood bases - See page 60.

### INDIVIDUAL GLASS

Tempered

GT1010 - 10"x10"

GT1016 - 10"x16"

GT1212 - 12"x12"

GT1414 - 14"x14"

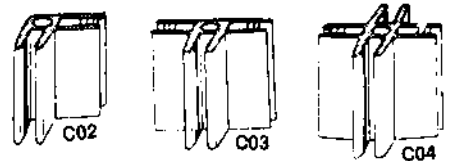

C02 -  
C03 -  
C04 -

### CHROME METAL CONNECTORS



2-WAY  
CON/2 - Chrome



3-WAY  
CON/3 - Chrome



4-WAY  
CON/4 - Chrome

## DRESSING ROOM MIRRORS

All Floor Mirrors Have Heavy Duty Metal Frames



### SQDAM - MIRROR

Attaches to side of SQDA (page 33) or SQV (page 32).

19" wide x 58" high

SQDAM

### SINGLE TILT FLOOR MIRROR

Chrome Frame  
20" wide  
x 60" high

Style TSM



### MIRRORED ALCOVE

Aluminum framed  
Center mirror  
is 20" x 60"  
2 side mirrors  
are 18" x 60"

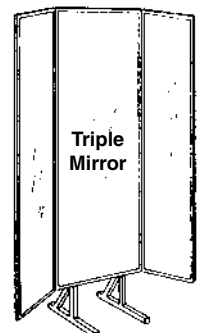

FSAH Free standing

Crated For Freight - \$35.00 Per Mirror

# GLASS DISPLAY MERCHANDISERS FOR CLOTHING OR GIFTWARE

Simple, easy to set up, glass display units come knocked down for easy shipping. Units sold as shown.

Tapered 16" glass, chrome connectors & high quality maple laminated finish base.



## WDGLOVMP

Unit is 55" H x 54" L x 30" W.  
Base is 6" H x 54" L x 30" W.  
Unit includes:

- 18 - 12" x 12" glass
- 18 - 12" quarter round glass
- 10 - 12" x 24" glass
- Chrome connectors



## WDGLRDMP

Rotating display unit 55" high x 30" diameter. Base is 6" high x 30" diameter. Unit includes:

- 12 - 12" x 12" glass
- 16 - 12" quarter round glass
- Chrome connectors

*Glass Display Merchandisers are shipped by truck.*

## BASES FOR GRID AND GLASS CUBE DISPLAY

Wood platform bases available in 2 sizes. Available in black, maple or white melamine finish. Shipped K.D. flat assembly required. Ships UPS.

For back to back display units combine 2 bases together.

Maple and black bases are 6" high. White bases are 9" high. Custom sizes are available.



	Dimensions	Color
WD5214-BK	52" L x 14" W	Black
WD6016-BK	60" L x 16" W	Black
WD5214-MP	52" L x 14" W	Maple
WD6016-MP	60" L x 16" W	Maple
WD5012-MP	50" L x 12" W	White
WD5012-BK	50" L x 12" W	Black
WD5814-MP	58" L x 14" W	White
WD5814-BK	58" L x 14" W	Black

## COLORED CUBES – PLASTIC COATED METAL GRID CUBES

All prices include Grid Squares and Same Color Clips to form units.

Add color and life to your store with these unbreakable grids from American!! Available in:

White!! – Add W to item # (Example D33W)

Black!! – Add B to item # (Example D33B)

Specify when ordering.

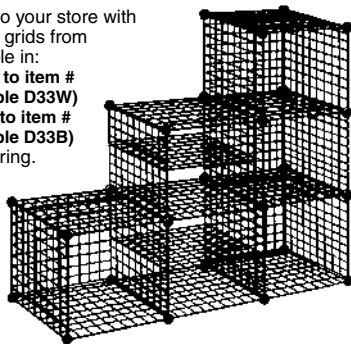

Cube Configurations Include Clips

### CUBE D

### CUBE E

	OPEN BACK	CLOSED BACK	OPEN BACK	CLOSED BACK
<b>3 HIGH X</b>				
3 Wide	D33	DC33	E33	EC33
4 Wide	D34	DC34	E34	EC34
5 Wide	D35	DC35	E35	EC35
6 Wide	D36	DC36	E36	EC36
<b>4 HIGH X</b>				
3 Wide	D43	DC43	E43	EC43
4 Wide	D44	DC44	E44	EC44
5 Wide	D45	DC45	E45	EC45
6 Wide	D46	DC46	E46	EC46
<b>5 HIGH X</b>				
3 Wide	D53	DC53	E53	EC53
4 Wide	D54	DC54	E54	EC54
5 Wide	D55	DC55	E55	EC55
6 Wide	D56	DC56	E56	EC56
<b>6 HIGH X</b>				
3 Wide	D63	DC63	E63	EC63
4 Wide	D64	DC64	E64	EC64
5 Wide	D65	DC65	E65	EC65
6 Wide	D66	DC66	E66	EC66

### SIZES OF GRID CUBE UNITS

Cube D – 16" deep x 10" high x 10" wide. (Uses 10" x 16" Grid.)

Cube E – 14" deep x 14" high x 14" wide. (Uses 14" x 14" Grid.)

### INDIVIDUAL COLORED GRID PANELS

- GRID14 Black or White, 14" x 14"
- GRID16C Black or White, 10" x 16"
- GRID10C Black or White, 10" x 10"

**COMPONENT PARTS**

### INDIVIDUAL CLIP CONNECTORS

- GSC/B – Black
- GSC/W – White

# CLEAR ACRYLIC DISPLAYERS



## SMALL RISERS

(1/8" thick) Sold in sets of 3 Pcs.  
Set includes:

FF/DR 5010

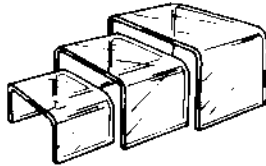

## MEDIUM RISERS

(1/8" thick) Sold in sets of 3 Pcs.

FF/DR 4510 – Set of 3

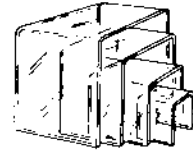

## LARGE RISERS

(1/4" thick) Sold in sets of 4 Pcs.

1054 – Set of 4



Shoe Mirror

## ACRYLIC MIRROR

1092 – 12" wide x 18" high,  
1/4" thick. Beveled and  
polished edges.

1091 – 9" wide x 12" high,  
1/4" thick.

## SMALL SHOE RESTS

1/6" Clear Acrylic

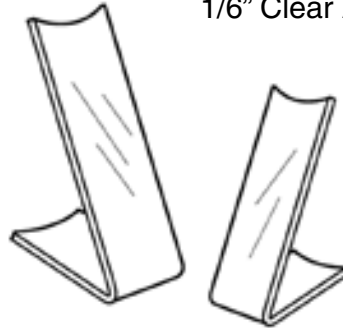

1240 – 1" W x 2-1/2" H  
1241 – 1-3/8" W x 4-1/4" H



## SHOE DISPLAY

1/4" Thick Acrylic

1232A – 9" L x 4" W x 5" H  
1232B – 9" L x 4" W x 7" H  
1232C – 9" L x 4" W x 7" H  
1233 – Set of 3

## Z-BEND FOR SHOES

Set of 3  
Beveled Edge  
Slant Shoe Risers

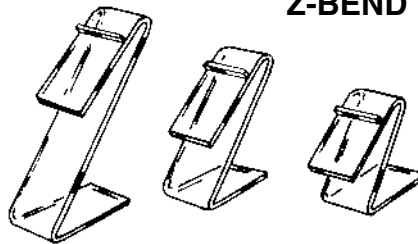

FF/ZSHOE3

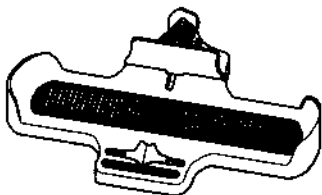

## BRANNOCK SHOE MEASURES

Style 4163A3E – Mens  
Style 3134AZE – Womens  
Style 114 – Childrens

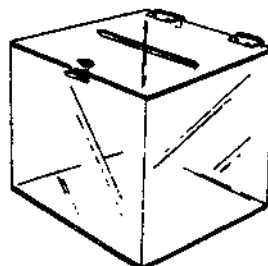

## BALLOT BOXES

With Locks

1023 - 8" W x 8" D x 8" H

1024 - 10" W x 10" D x 10" H

Available with  
or without lock.

# PEGBOARD HOOKS & WATERFALLS

Universal fitting for all pegboards.

Made in two gauges: .148 (fits 1/8" holes) and .225 (fits 1/8" holes).

## SAFETY END FEATURE



### HEAVYWEIGHT

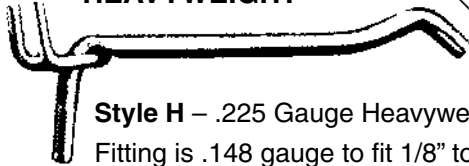

**Style H** – .225 Gauge Heavyweight Peg Hook.  
Fitting is .148 gauge to fit 1/8" to 1/4" pegboard.

H-4	4" Long
H-6	6" Long
H-8	8" Long
H-10	10" Long
H-12	12" Long

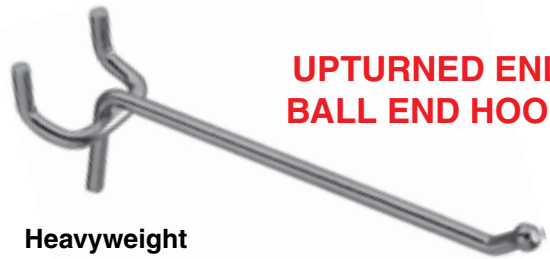

## UPTURNED END BALL END HOOK

**Heavyweight**  
**Style PGH** .225 gauge.  
**Bright zinc finish.**

PGH2	2" Long
PGH4	4" Long
PGH6	6" Long
PGH8	8" Long
PGH10	10" Long
PGH12	12" Long

## WATERFALL PEGBOARD HOOKS

DISPLAY HANDBAGS,  
NECKLACES, CUPS,  
UMBRELLAS.

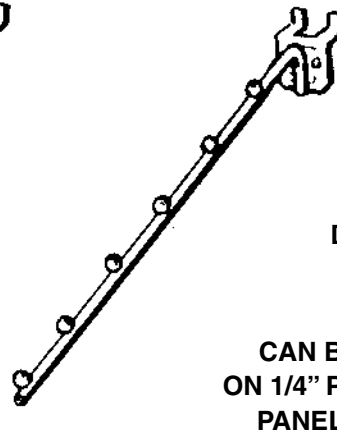
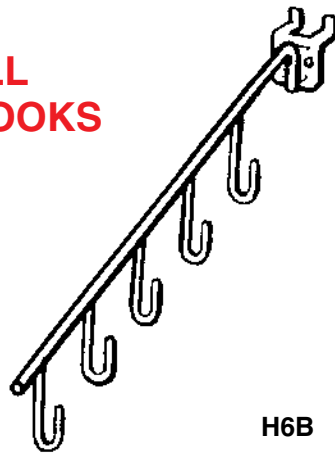

SHOW MORE!  
SELL MORE!

Display Apparel  
on Hangers.

CAN BE USED  
ON 1/4" PEGBOARD  
PANELS ONLY.

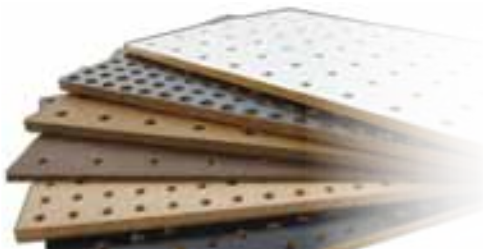

## PEGBOARD PANELS

48" x 96" panels,  
7/32" thick High Density Fiberboard (HDF).

9/32" diameter holes. Holes are  
1" center to center.

Choice of colors: ready to paint,  
white, black, maple or beige.

**PB48** – Ready to paint  
**PB48B** – Black  
**PB48W** – White  
**PB48M** – Maple  
**PB48BG** – Beige

# DO-IT-YOURSELF SINGLE SLOTTED SUSPENSION SYSTEMS

All standards are satin zinc color except for SS120 which is chrome.

EASY TO INSTALL – SPACE STANDARDS 4' OR 5' APART, DEPENDING ON WEIGHT LOAD. RECOMMENDED FOR MEDIUM LOADS. PERFECT FOR HANGRAIL DISPLAYS, WATERFALL DISPLAY OR SHELVING.

All brackets on this page fit Single Slot Standards illustrated below.  
For shelf brackets see page 65 (GA, 512, C12, C14 & 512AA).

## Chrome WATERFALL DISPLAY

Attach to standards for a great display

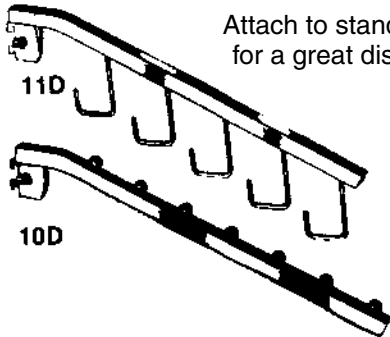

11D & 10D

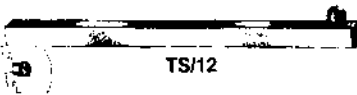

TS/12

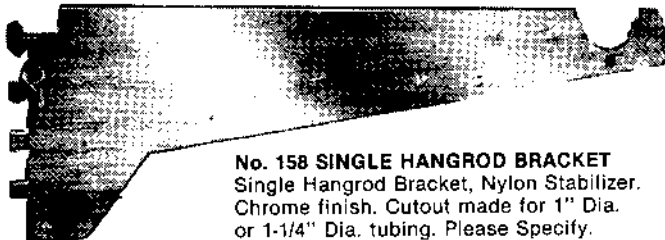

**No. 158 SINGLE HANGROD BRACKET**  
Single Hangrod Bracket, Nylon Stabilizer.  
Chrome finish. Cutout made for 1" Dia.  
or 1-1/4" Dia. tubing. Please Specify.

Style	Length
158A12	12" long, 1" dia
158A14	14" long, 1" dia
158B12	12" long, 1-1/4" dia
158B14	14" long, 1-1/4" dia

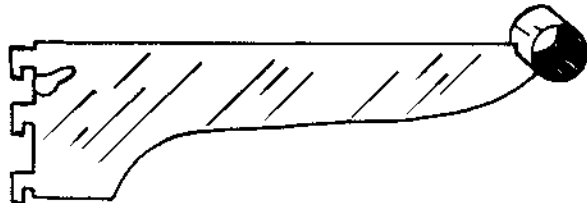

## BRACKET WITH TUBE ATTACHED

158T – To fit Universal 1/2" slots centers. With Nylon Stabilizers, 2 set screws in tube to hold hangrail. Chrome.

Style	Length
158TA12	12" long, 1" dia.
158TA14	14" long, 1" dia.
158TB12	12" long, 1-1/4" dia.
158TB14	14" long, 1-1/4" dia.

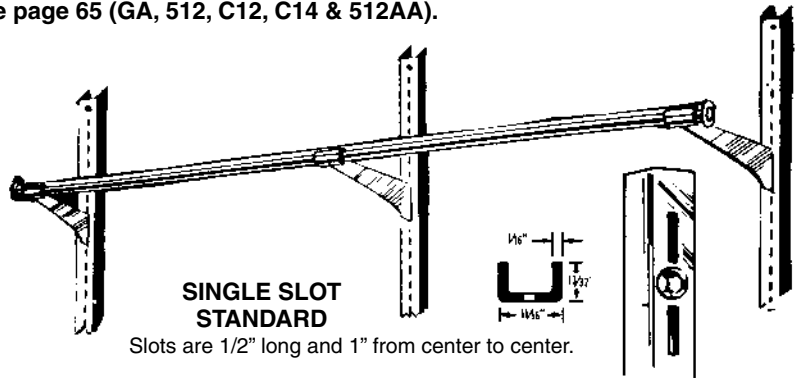

## SINGLE SLOT STANDARD

Slots are 1/2" long and 1" from center to center.

Style	Length
SS36	36"
SS48	48"
SS60	60"
SS72	72"
SS84	84"
SS96	96"

## HANGRAIL DISPLAY HEAVYWALL CHROME TUBING



Heavyweight 1" Dia. Tubing

TBE48	1" dia. x 4 ft.
TBE60	1" dia. x 5 ft.
TBE72	1" dia. x 6 ft.
TBE96	1" dia. x 8 ft.
TBE120	1" dia. x 10 ft.
TBE144	1" dia. x 12 ft.

## Super Heavyweight 1-1/4" Dia. Tubing

SBE48	1-1/4" dia. x 4 ft.
SBE60	1-1/4" dia. x 5 ft.
SBE72	1-1/4" dia. x 6 ft.
SBE96	1-1/4" dia. x 8 ft.
SBE120	1-1/4" dia. x 10 ft.
SBE144	1-1/4" dia. x 12 ft.



## END CAP

Completes the lock.  
Slips into end of tube to prevent garment from falling off bar.

631A	For 1" dia. tubing
631B	For 1-1/4" dia. tubing

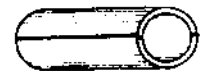

## JOINING SLEEVE

Connects tubes from the inside for strength and rigidity.

JS	For 1" dia. tubing
JS1	For 1-1/4" dia. tubing



# DO-IT-YOURSELF HEAVY-DUTY DOUBLE SLOTTED SUSPENSION SYSTEMS

All standards are satin zinc color except for DS96 which is chrome.

## RECOMMENDED FOR MEDIUM TO HEAVY LOADS

All brackets on this page fit double slot standards illustrated below. Standards have slots that are 1/2" long and 1" from center to center.

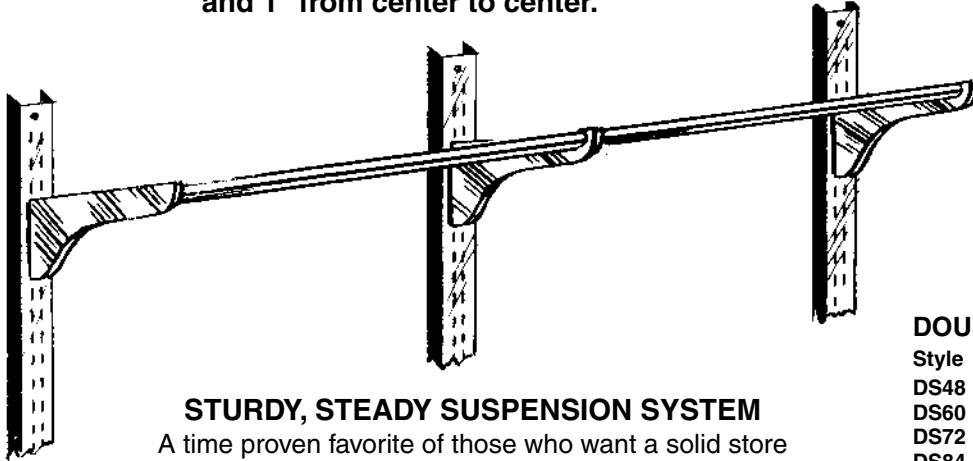

### STURDY, STEADY SUSPENSION SYSTEM

A time proven favorite of those who want a solid store hardware system. Double bladed brackets eliminate lateral play and carry heavy loads.



### DOUBLE SLOT STANDARD

Style	Length
DS48	48"
DS60	60"
DS72	72"
DS84	84"
DS96	96"

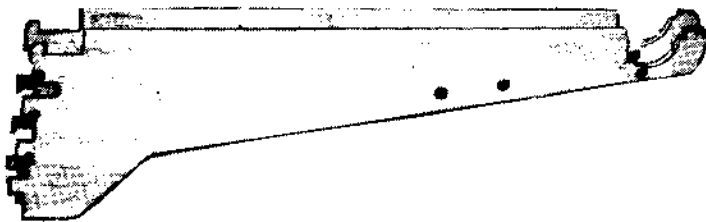

### 5503 – DOUBLE SLOT HANGROD BRACKET

Chrome finish for 1" or 1-1/4" tubing.

Style	Length
5503A12	12" long, 1" dia.
5503B12	12" long, 1-1/4" dia.



### 5505 – ALL CHROME DOUBLE BRACKET WITH TUBE

Eliminates need for hold-downs. Tube has 2 set screws to hold pipe. Holds 1" dia. or 1-1/4" tubing.

Style	Length
5505A12	12" long, 1" dia.
5505B12	12" long, 1-1/4" dia.
5505A14	14" long, 1" dia.
5505B14	14" long, 1-1/4" dia.

## FACE IN TUBING SYSTEM

Use in areas where you have two walls facing each other. Convert dead space into important selling space. Typically used in closet systems.

### For Wall

#### SCREW-IN WALL FLANGES

##### ROUND FLANGE



All chrome round flange

RF1 -For 1" tube  
RF2 -For 1-1/4" tube

##### U-FLANGE



All chrome open U flange

UF1 -For 1" tube  
UF2 -For 1-1/4" tube

### For Standards

#### FACE IN BRACKET for Standards



FACE IN BRACKET

5634A  
For 1" dia.

5634B  
For 1-1/4" dia.



DRESSING ROOM HOOK

61A – 3" ALL CHROME DRESSING ROOM WALL HOOK



HEAVY WALL CHROME TUBING

Heavyweight  
1" Dia. Tubing  
Super Heavyweight  
1-1/4" Dia. Tubing  
(See page 63)

# SHELVING BRACKETS

Below listed brackets fit into SS Standards (page 63) and DS Standards (page 64).  
Perfect for support of shelves or formica wood shelves (see page 67). Satin Zinc Plated.

## TAP IN SHELF BRACKET

Sturdy and economical (Zinc Plated). Fits 1/2" on 1" Center Standards. See pages 64 and 65.  
Also, available in 6", 8", and 16".

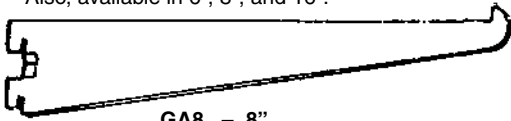

- GA8 - 8"
- GA10 - 10"
- GA12 - 12"
- GA14 - 14"
- GA16 - 16"

## ZINC PLATED SLANT BRACKET

#512AA  
Adjustable Slant Bracket  
Slant 15°, 30°, 45°, 60°  
512AA - Fits 1/2" on 1" Center Standards

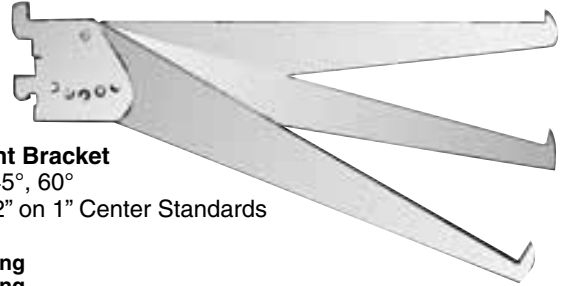

- 512AA10 - 10" long
- 512AA12 - 12" long
- 512AA14 - 14" long

## WOOD SHELF BRACKETS

Center, right or left ledge to rest shelf.  
Screws fit thru bracket to hold shelf.



- WBL12 - 12" left ledge
- WBR12 - 12" right ledge
- WBC12 - 12" center ledge
- WBL14 - 14" left ledge
- WBR14 - 14" right ledge
- WBC14 - 14" center ledge

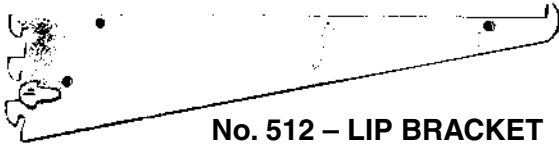

## No. 512 - LIP BRACKET

Zinc Plated with Nylon Stabilizer. Fits 1/2" on 1" Center Standards. See pages 63 and 64. Also, available in 8" and 16".

- 51210 - 10"
- 51212 - 12"
- 51214 - 14"

## EXTRA HEAVY-DUTY SINGLE SLOT STANDARD

Slots are 1" long and 2" from center to center of slot.



SHELF BRACKETS: G12 & G14 (below)  
WATERFALLS: RR7B, RR5H, RR/12 (page 47)  
HANGRAIL BRACKETS: GR3, GR12, (page 66)

Style	Length
SSH36	36"
SSH48	48"
SSH60	60"
SSH72	72"
SSH84	84"
SSH96	96"
SSH120	120"
SSH144	144"

## Shelf Supports

Centers & Rubbers for glass shelves. 514 fits on GA, 512 and 512AA brackets. LKC fits on G12, G14 and G16.

517 - Rubber bumper fits into 514 and LKC



514 - Has 2 holes for rubber bumpers



LKC - For G style brackets

## HEAVY-DUTY SHELF AND HANGRAIL BRACKETS



"G" Blade

Heavy-duty bracket for snap-on attachment for 1" slots on 2" center standards. (See above.)  
Use as shelf brackets or hangrail bracket.

G12 & G14 - (Fits 1" on 2" slotted standard) (see above)  
C12 & C14 - (Fits 1/2" on 1" slotted standard) (see pages 63 & 64)

- G10 10" Long Blade
- G12 12" Long Blade
- G14 14" Long Blade
- G16 16" Long Blade

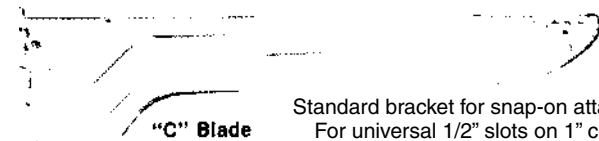

"C" Blade

Standard bracket for snap-on attachment. For universal 1/2" slots on 1" centers. Use as shelf brackets or hangrail bracket.

- C12 12" Long Blade
- C14 14" Long Blade

## SNAP ON ATTACHMENTS

Snaps onto either G or C blade for holding hangrails securely.

### FOR ROUND TUBING

DC1 - For 1" dia. tubing  
DC2 - For 1-1/4" dia. tubing

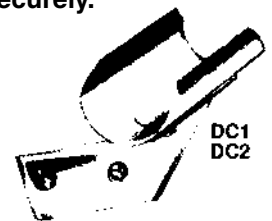

### FOR ROUND TUBING

RC8 - For 1" dia. tubing  
RC9 - For 1-1/4" dia. tubing

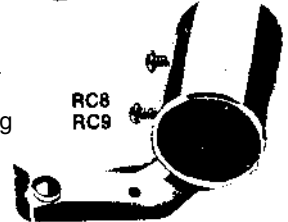

### FOR RECTANGULAR TUBING

For 1/2" x 1-1/2" rectangular tubing.

AC7 - Center attachment to hold rectangular tube.

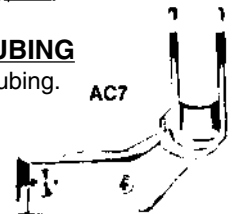

# CHROME RECTANGULAR TUBING DISPLAYS

Brackets, tubing and attachments are available in Matte Black at the same price. Indicate B after style number. Also available in Satin Chrome and White.

## BRACKETS FOR STANDARDS 1" SLOTS ON 2" CENTERS

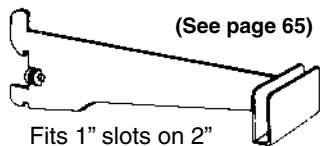

Fits 1" slots on 2" center standards only.

**GR12 – 12" Long Bracket**

**GR8 – 8" Long Bracket**

### GR3 – 3" Long Bracket

Holds 1/2" x 1-1/2" rectangular tubing for heavy duty 1" slots on 2" center standards.

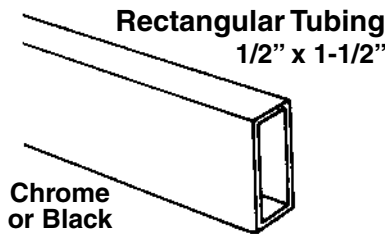
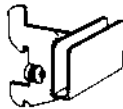

**Chrome  
or Black**

- RE24 – 24" long
- RE48 – 48" long
- RE60 – 60" long
- RE72 – 72" long
- RE96 – 96" long
- RE120 – 120" long
- RE144 – 144" long

## BRACKETS FOR STANDARDS 1/2" SLOTS ON 1" CENTERS

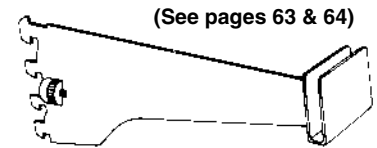

Fits 1/2" slots on 1" center standards only.

**REC12 – 12" Long Bracket**

**REC8 – 8" Long Bracket**

### REC3 – 3" Long Bracket

Holds 1/2" x 1-1/2" rectangular tubing.

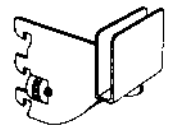

### Rectangular Joining Sleeve JS3

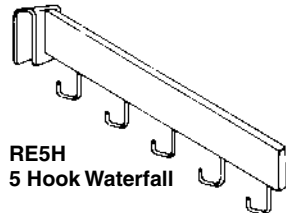
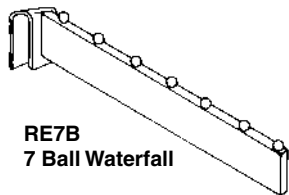

**RE14K  
14" Straight**

### END CAP The Finishing Touch EC3

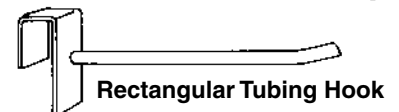
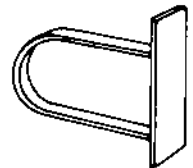

- RE4 – 4" Hook
- RE6 – 6" Hook
- RE9 – 9" Hook
- RE12 – 12" Hook

## RECESSED STANDARDS Black or Zinc Finish

Heavy Duty 1" slots on 2" centers. Standard is concealed behind 3/4" Slatwall (13/16" depth) or 5/8" Sheetrock (11/16" depth). Recessed Standards are also available with 1/2" slots on 1" centers.

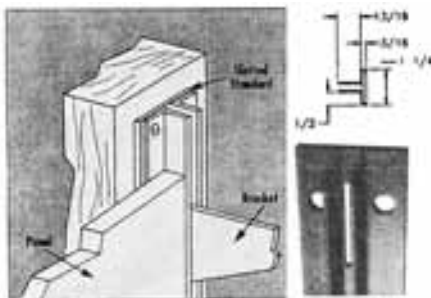

Standards conceal behind Sheetrock or Slatwall

Length	For 3/4"		For 5/8"	
	13/16" Depth (Slatwall)		11/16" Depth (Sheetrock)	
72"	CS72 – Zinc	CS72B – Black	SR72 – Zinc	SR72B – Black
96"	CS96 – Zinc	CS96B – Black	SR96 – Zinc	SR96B – Black
120"	CS120 – Zinc	CS120B – Black	SR120 – Zinc	SR120B – Black
144"	CS144 – Zinc	CS144B – Black	SR144 – Zinc	SR144B – Black

Use G Series brackets & attachments on pages 65, 66.

# SHELVING

## Bullnose Shelving

Shelving Breakthrough!! Injected molded, low cost, durable shelving. Available in 13" and 15" deep for use with 12" or 14" brackets. Brackets are concealed under bullnose. Bullnose design offers a rich clean look!! Minimum 4 shelves. Translucent clear frosted bullnose shelving is also available. Save money over the cost of glass shelving. Call for price.



### Stock Colors

- White
- Black
- Grey
- Almond
- Clear Frosted

### Custom Colors Available

Minimum 12 Shelves

Mahogany • Oak • Walnut • Marble • Clear Frosted

Call for Color Chart

### 13" Wide Shelves (use with 12" brackets)

Style	Color	Size
224B	Black	13" x 24"
224W	White	13" x 24"
224G	Grey	13" x 24"
224A	Almond	13" x 24"
236B	Black	13" x 36"
236W	White	13" x 36"
248B	Black	13" x 48"
248W	White	13" x 48"
248G	Grey	13" x 48"
248A	Almond	13" x 48"

### 15" Wide Shelves (use with 14" brackets)

Style	Color	Size
424B	Black	15" x 24"
424W	White	15" x 24"
448B	Black	15" x 48"
448W	White	15" x 48"

## GLASS SHELVING

Glass 3/16" Thickness  
Polished Edge

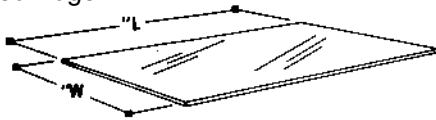

### TEMPERED GLASS SHELVING

24" LONG

- 10" 1024CL
- 12" 1224CL
- 14" 1424CL

48" LONG

- 1048CL
- 1248CL
- 1448CL

SOLD IN FULL CASE PACKS ONLY, 5 PER PACK.  
SHIPPED BY TRUCK.

## WOOD SHELVING

Wood 3/4" Thickness  
Melamine Finished On 6 Sides

MINIMUM ORDER  
24" Shelves – 8 pcs.  
48" Shelves – 4 pcs.

24" LONG

- PW/1224 BK 12"x24" Black
- PW/1224 WH 12"x24" White
- PW/1224 MP 12"x24" Maple

48" LONG

- PW/1248 BK 12"x48" Black
- PW/1248 WH 12"x48" White
- PW/1248 MP 12"x48" Maple
- PW/1448 BK 14"x48" Black
- PW/1448 WH 14"x48" White
- PW/1448 MP 14"x48" Maple

## MOBILE STACKABLE BASKETS



Chrome heavy duty stackable bins.  
Unit contains 4 baskets.  
Each basket is 24" wide x 21" deep  
x 11" high. 43" high.  
2 locking and 2 non-locking.  
Heavy duty wheels.

**New Lower Price** Also available in White.

SP4 – 48" high

## GIANT GRID BIN

Available in 36" square or 48" square, black, white or chrome.  
Units are 32" high.

Wheels will add 3" to height.

36" model includes wheels.  
48" model does not include wheels

**GB36B** – Black 36" square  
**GB36W** – White 36" square

**GB36C** – Chrome 36" square

**GB48B** – Black 48" square  
**GB48W** – White 48" square

Add \$12.00 per set for wheels.  
**GB48C** – Chrome 48" square

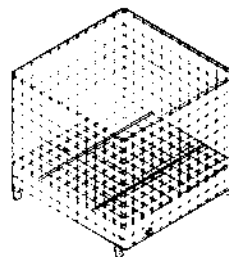

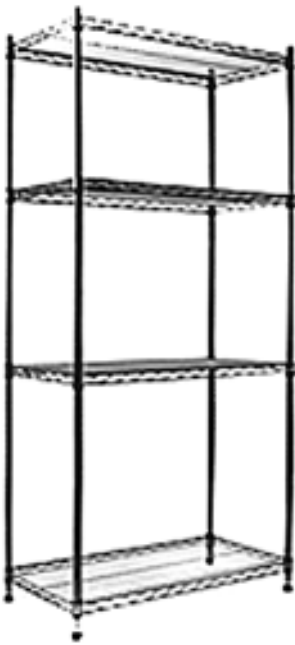

## WIRE SHELVING UNITS

All purpose wire merchandisers have endless applications for all retailers. Mirror chrome finish, 74" high with 4 wire shelves. 3 different widths and depths to choose.

Style	Dimensions
71836C	74" high, 18" x 36" shelves
71848C	74" high, 18" x 48" shelves
72448C	74" high, 24" x 48" shelves

Optional accessories include locking and non locking casters, and S hooks to create a right angle with two units.

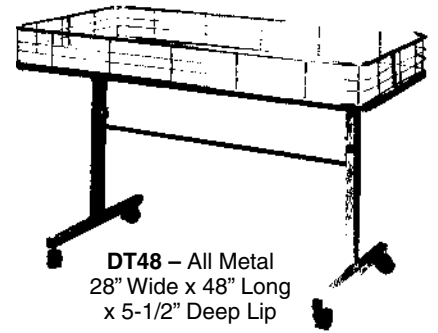

DT48 – All Metal  
28" Wide x 48" Long  
x 5-1/2" Deep Lip

DT48/C – Chrome

DT48/B – Black  
DT48/W – White

## FOLDING GLASS TOWERS



FLT52

FLT37

FLT68

FLT68  
Signholders

## ECONOMY THREE TIER TABLES

Choice of square or rectangle.  
Maple melamine finish.  
All colors available. Call for price.



### SQUARE

WD3SQ – 48" square x 42" high.  
Bottom shelf is 48" x 48", middle is 36" x 36" and top is 24" x 24".  
Bottom shelf is 10" from floor.  
Maple color or Black.

WD3SQMP – Maple  
WD3SQB – Black

### RECTANGULAR

WD3RTMP – 60" long x 42" wide x 42" high. Bottom shelf is 42" x 60", middle is 34" x 60" and top shelf is 18" x 52".  
Bottom shelf is 10" from floor.  
Maple color.

## FOLDING GLASS TOWERS

- 3 sizes 37", 52", or 68" high
- Shelves adjustable every 1"
- Folds up for easy storage
- Chrome or brushed chrome finish
- Includes levelers
- 3/16" thick tempered glass 18" square

FLT37CGLS	37" high x 18" square, 3 shelves, chrome.
FLT37BCGLS	37" high x 18" square, 3 shelves, brushed chrome.
FLT52CGLS	52" high x 18" square, 4 shelves, chrome.
FLT68CGLSNS	68" high x 18" square, 5 shelves, chrome.
FLT68BCGLSNS	68" high x 18" square, 5 shelves, brushed chrome.

### 68" HIGH GLASS TOWER WITH SIGN FRAMES (AS SHOWN ABOVE)

FLT68CGLS	68" high x 18" square, 5 shelves, chrome. Includes 4 – 4" high x 17" wide magnetic signholders.
FLT68BCGLS	68" high x 18" square, 5 shelves, brushed chrome. Includes 4 – 4" high x 17" wide magnetic signholders.

Tables Ship Freight Only



# ECONOMICAL ALTERNATIVES

Functional yet inexpensive display to spread throughout your store!  
Available either as a floor model, counter top model or a rack topper. Men's (unisex) and ladies' units are available with a matte black finish. Children's unit is in a matte white finish only.

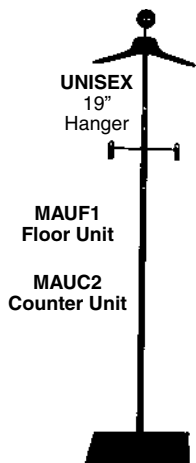

**UNISEX**  
**FLOOR STANDING UNIT**  
For menswear & large size ladies. Has a 15" x 15" base. 19" hanger with ball top. 53"-72" adjustable upright. Clip waist attachment.

**MAUF1 - Matte Black**

**COUNTER TOP UNIT**  
Has a 10" x 10" base. 19" hanger with ball top. 46" adjustable upright. Clip waist attachment.

**MAUC2 - Matte Black**

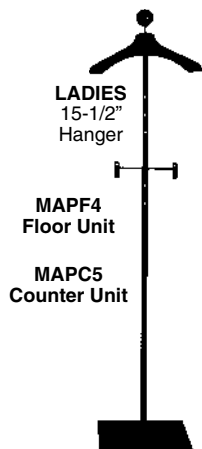

**LADIES**  
**FLOOR STANDING UNIT**  
For ladies & junior wear. Has a 15" x 15" base. 15-1/2" hanger with ball top. 53"-72" adjustable upright. Clip waist attachment.

**MAPF4 - Matte Black**

**COUNTER TOP UNIT**  
Has a 10" x 10" base. 15-1/2" hanger with ball top. 46" adjustable upright. Clip waist attachment.

**MAPC5 - Matte Black**



**CHILDREN'S**  
**FLOOR STANDING UNIT**

For children's wear display. 10" x 10" base, with 12" hanger with ball top. 46" adjustable upright. Small clip waist attachment.

**MADC7 - Matte White**



## TOPS LINE

Adjustable height. Pant or skirt bar. Black matt finish.

**Tops1 - Crescent Head**  
**Tops2 - Globe Head**

**Tops3 - Globe Counter Model**

## FLEXI-FORMS



The Ultimate FlexiForm! Plush covered aluminum rod adjusts to any position. 3/8" fitting for mounting to stand.

Use with 208F stand. (Sold separately.)

**FF80 - Adult (w/o stand)**

**FF81 - Child (w/o stand)**

FF80 can be used with a floor stand (see 208F, page 70) or hung from a ceiling or wall.

## FLEXI ROD

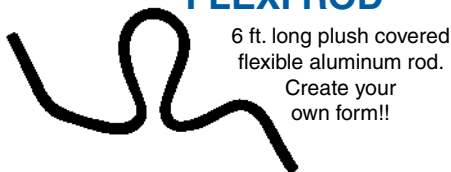

6 ft. long plush covered flexible aluminum rod. Create your own form!!

**FF80 (Adult)**  
**FF81 (Kids)**

**FF82B - Black FlexiRod**

## ARROW DISPLAYERS



**Aro103**  
**TEEN**  
**53" High**

**Aro105**  
**CHILD**  
**38" High**

**Aro100**  
**ADULT**  
**72" High**

Brand new, inexpensive display alternative from American!! Easy to dress. Top hanger and waist holder adjust in height for easy changing of display. Matte black finish. Wood base & metal body. Available in 3 sizes for adults, teens, & children. Give your selling floor a beautiful, clean display addition.

**Aro100 - Adult (Ladies & Mens)**  
**Aro103 - Teen (Size 7-14)**  
**Aro105 - Child (Size 3-6X)**

# BASES & DISPLAY FIXTURES

## ADJUSTABLE CHROME STANDS

Combine stands with interchangeable tops, sign frames and displays.

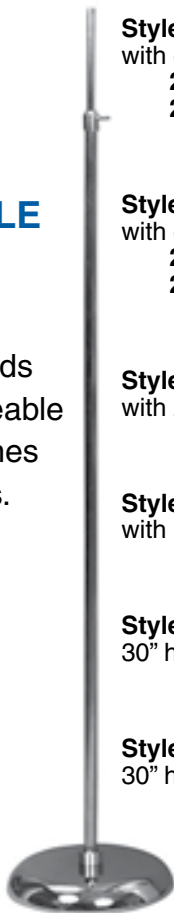

**Style 204** – 4" diameter base with choice of extension.  
**204A** – 9"-18" extension, 3/8" fitting  
**204D** – 18"-36" extension, 3/8" fitting

**Style 205** – 5" diameter base with choice of extension.  
**205A** – 9"-18" extension, 3/8" fitting  
**205D** – 18"-36" extension, 3/8" fitting

**Style 206D** – 6" diameter base with 24"-48" extension, 3/8" fitting.

**Style 208F** – 8" diameter base with 36"-72" extension, 3/8" fitting.

**Style 830** – 8" diameter base, 30" high upright, 5/8" fitting.

**Style 1036** – 10" diameter base, 30" high upright, 5/8" fitting.

## DRESSMAKER BASE ON WHEELS

For use with Jersey Forms on page 72.

**DMB/1** – Chrome base with 48" upright, including spring and wheels.

**DMB/2** – Raw steel with 48" straight upright, spring and wheels.

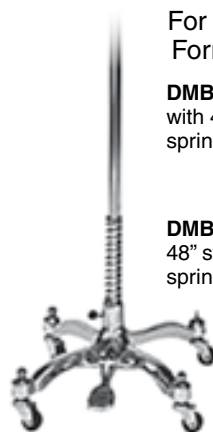

## INTERCHANGEABLE TOPS



**BLOUSE TOP**

**C305** – 17" wide, 3/8" fitting

1/4" fitting for use with 4" or 5" base and extension. 3/8" fitting for use with 6", 8" or 10" base.

## SHIRT & BLOUSE FORMS

Inexpensive full round black forms. Stands on its own.

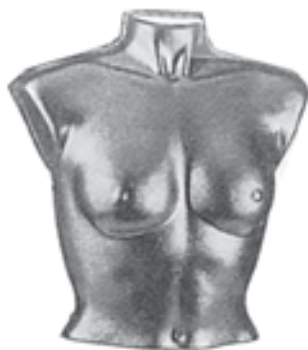

**SC2002** – Women's



**SC2003** – Men's

## HEADS

Beautiful Flesh Tone Display Heads for hats, jewelry and accessories. Hard rubber interior. Life like make up.



**HIF**

**HIF** – Female  
**HIM** – Male



**HIM**

Check out selections of other styles of heads on page 78.

# HANGING TORSOS

All forms are easy to pin for a better presentation.

All hanging forms have wire loop attached to neck block.

Men's, Kid's and Women's forms are in creme color.

## Wire Hanging Forms

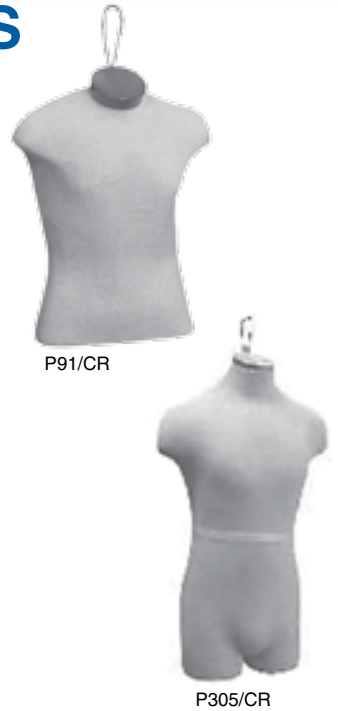
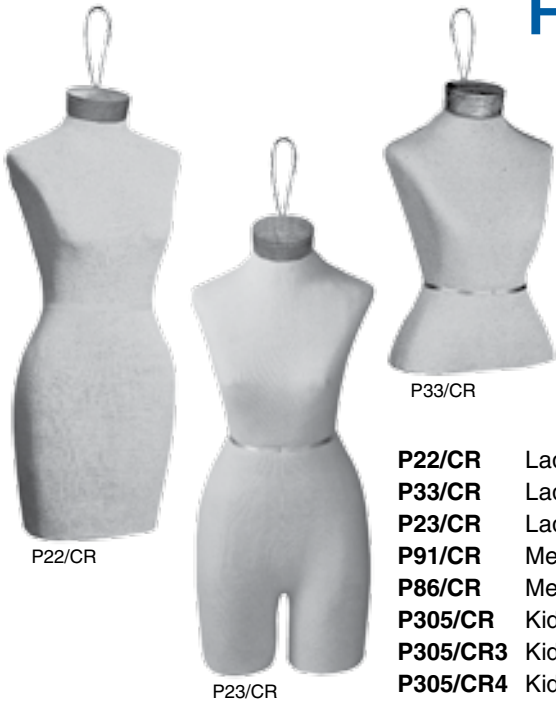

- P22/CR** Ladies dress form, creme
- P33/CR** Ladies blouse form, creme
- P23/CR** Ladies 3/4 torso, creme
- P91/CR** Men's muscular shirt, creme
- P86/CR** Men's 3/4 torso, creme
- P305/CR** Kids 3/4 torso, creme, 2 yr. old
- P305/CR3** Kids 3/4 torso, creme, 4-6 yr. old
- P305/CR4** Kids 3/4 torso, creme, 8-10 yr. old

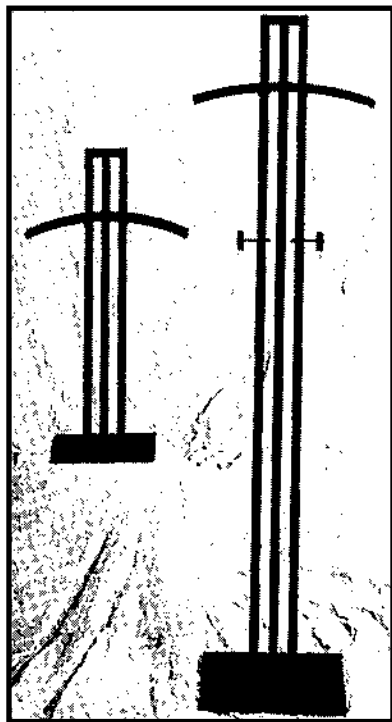

## SQUARE TUBING COSTUMERS

Epoxy coated matte black finish. Removable hangers facilitates dressing form. All steel construction. Heavy metal base.

**TRP36**  
Countertop  
Displayer  
36" High)

**TRP72**  
Floor Standing  
Displayer  
72" High

VM504/MAB  
VM504/MTW  
VM504/SC

## ADJUSTABLE NOTCHED COSTUMER

Adjustable in height from 49"-78"

VM504/MAB - Black  
VM504/MTW - White

VM504/SC - Satin Chrome

## LARGE SIZE BRAZILIAN FORM WITH ARMS



Fleshtone unbreakable display forms, metal base, size 18, with arms.

**49/FFBARM**

## LARGE SIZE BRAZILIAN FORM



Fleshtone unbreakable display forms, metal base, size 18.

**49/FFB**

# BRAZIL FORMS

*Fleshtone Unbreakable Full Round Display Forms  
Metal Base Included*

Ladies Full Form  
Regular Breast



12/FFB

Ladies Full Form  
Large Breast



12/FBB

Ladies Full  
Form



Mens Full  
Form



24/FH

Ladies Pants



12/F

Mens Pants



12/MP

## JERSEY COVERED DISPLAY



Our basic in stock combination is with a natural wood color base and neck block with a cream jersey. F305 and K305 pictured are examples of this combination.

*Dress Maker metal bases on wheels available, see page 70.  
Can replace any wood base shown above.*

Men's and Ladies' classic forms! Durable construction for easy pinning. Choice of grey, white, cream, or black jersey. Choice of walnut or natural bases and neck blocks. Sold as a complete set!! Custom sets available, call for quotes! Adjustable in height.

*Jersey Colored Forms F305, F309, H303, K305 stocked in cream color jersey and natural wood color base. H304 in stock in grey jersey with walnut base.*

- F305** – Ladies' Dress Form
- F309** – Ladies' Blouse Form
- H303** – Men's Coat Form
- H304** – Men's Shirt Form
- K305** – Kid's Full Form 6-8 Yr. Old

Prices are for our basic combination of natural wood color base and neck block and cream color jersey. Black or white bases and neck blocks are available at a higher price. Also custom sizes available. Metal neck caps and bases available. Call for price.



# COLORFUL TORSOS



## FEMALE BLOUSE

21-1/2" high x 31" bust,  
Waist 24"

10W - White  
10BLK - Black  
10F - Flesh



## MALE SHIRT

28" high x 40" bust,  
Waist 30"

27W - White 27B  
- Black

Sturdy  
polypropylene  
free standing forms  
at low prices.  
Three colors that  
brighten up  
your displays.

Hang 7, 10, 23, 27  
on stands, walls,  
Slatwall,  
or Gridwall using  
the CF45  
(Cable Loop).

**CF45** –  
4-1/2" Cable Loop



## FEMALE TORSO

27-1/2" high x 33" bust,  
Waist 26"

7W - White  
7B - Black  
7F - Flesh



## MALE TORSO

40" high x 36-1/2"  
chest, Waist 30"

23W - White  
23B - Black  
23F - Flesh



## TORSO FORM

Swimsuit  
Sizes 7-8

11F – Flestone  
11B – Black  
11W – White



## TORSO FORM

Size 12

15F – Flestone  
15B – Black  
15A – White



## FEMALE ACTION TORSO

32" High x 35" Bust,  
28" Waist. Flesh Color.

75AF – Flesh

Wood Base included.

Wood Base included.

# SHORTS & UNDERWEAR FORMS

Durable Plastic Construction



## Male Shorts Form

30" waist, 37-1/2" hip,  
15" height

19B – Black  
19F – Flesh  
19W – White

## Female Shorts Form

27-1/2" waist, 39-1/2" hip,  
18" height

17B – Black  
17F – Flesh  
17W – White





**NEW  
Lower  
Prices!**

# MANNEQUINS

Beautifully constructed, life like! Heavy duty construction.  
Fully movable arms & hands! Wigs & bases included. All mannequins ship UPS.



## ELEGANTE

*IN STOCK! SHIPPED UPS.*

## MAVERICK

Elegante and Maverick have base fittings in the calf.



LISA2

LISA3

LISA6

All mannequins have makeup applied.

## LISA

Fleshtone color with wig and makeup.

## AFRICAN AMERICAN MANNEQUINS

## FLESH COLOR MOLDED HAIR



MZW3 – Male

MDA – Female

MZW5 – Male



LFH2 – Female Seated



AM1

AF2

AF1

MENS – AM1

WOMANS – AF2, AF1

# “EGGHEAD” ABSTRACT MANNEQUINS

Choice of glossy white, black, grey finish. Glass base with fitting in calf or heel.  
Also, available in matte white finish and mirror chrome finish.

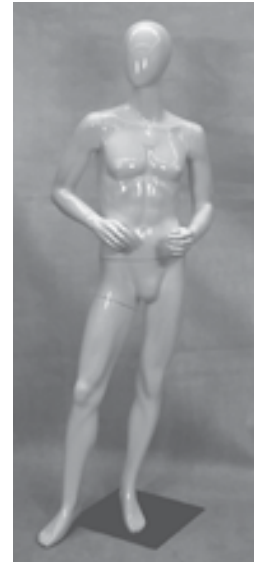

## GLOSSY FINISH

**EGA2W** – White    **EGA3W** – White    **EGA4W** – White  
**EGA2B** – Black    **EGA3B** – Black    **EGA4B** – Black

**EGG53W** – Glossy White  
**EGG53B** – Glossy Black  
**EGG53MW** – Matte White

**EGG54W** – Glossy White  
**EGG54B** – Glossy Black  
**EGG54MW** – Matte White

## MALE EGGHEAD MANNEQUINS

Chest 37”, waist 30”, hip 37”, 72” tall, 10” shoe.

## MATTE FINISH

**EGA2WM** – White    **EGA3WM** – White    **EGA4WM** – White  
**EGA2BM** – Black    **EGA3BM** – Black    **EGA4BM** – Black

## GLOSSY FINISH

## MATTE FINISH



## EGGHEAD PLUS SIZE

**MATTE WHITE FINISH**  
**EGN1M, EGN2M, EGN3M**

**GLOSSY FINISH**  
**EGN1, EGN2, EGN3**

**EGN1M    EGN2M    EGN3M**

Matte white, 41” bust, 32” waist,  
43” hip, 6’ high, size 9 shoe.

## HEADLESS PLUS SIZE



**NHA7F**

Fleshtone, 40” bust,  
34-3/4” waist, 42-1/2” hip,  
5’5” high. Size 14.

# HEADLESS MANNEQUINS



## WOMEN'S

- Fiberglass construction
- Base inserts into calf
- UPS shippable

Each model is available in the following colors.

- Glossy White
- Glossy Black
- Flestone
- Matte White

**NHA2** – Arms out  
**NHA3** – Arms at side  
**NHA4** – Arms at hip

**NHA2W, NHA3W, NHA4W** – Glossy White  
**NHA2B, NHA3B, NHA4B** – Glossy Black

**NHA2F, NHA3F, NHA4F** – Flestone  
**NHA2MW, NHA3MW, NHA4MW** – Matte White



## MEN'S

- Fiberglass construction
- Base inserts into calf
- UPS shippable

Each model is available in the following colors.

- Glossy White
- Glossy Black
- Glossy Silver
- Matte White

**NHA5** – Arms at hip  
**NHA6** – Arms at side

**NHA5W, NHA6W** – Glossy White  
**NHA5B, NHA6B** – Glossy Black  
**NHA5S, NHA6S** – Glossy Silver  
**NHA5MW, NHA6MW** – Matte White

# MOTORIZED TURNTABLES

Rotate mannequins and forms from the ceiling or on the selling floor.  
 Gives your customers a complete presentation.

## FLOOR TURNTABLES



**RB18** – 18" Dia.



**Floor Model** – 17" diameter.  
 Let your customer get the total view! 50 lb capacity.

**Vue 17** – 17" Diameter  
**Vue 12** – 12" Diameter

## CEILING TURNER



Set beautiful displays rotating from your ceiling

**Vue 15** – 15 lb. capacity  
**Vue 40** – 40 lb. capacity

# KIDS MANNEQUINS

*Flesh Tone Kids with Molded Hair and Metal Base*



**K514**

**K514**  
 4-5 yr. old Girl



**K303**

**K303**  
 4-5 yr. old Boy



**K511**

**K511**  
 6-8 yr. old Boy



**K509**

**K509**  
 6-8 yr. old Girl



**K508**

**K508**  
 10-12 yr. old Girl



# CHILDREN'S HEADLESS MANNEQUINS

## KID4NH

2 year old, Size 2  
Height: 29"  
Chest: 20-1/2"  
Waist: 20-1/2"  
Hips: 21-1/2"

## KID6STNH

4 year old, Size 4  
Height: 37"  
Chest: 22"  
Waist: 20"  
Hips: 23-1/2"

## KID6NH

6 year old, Size 6  
Height: 42"  
Chest: 23-1/2"  
Waist: 22-1/2"  
Hips: 26"

White color. Metal base fits into the calf or heel.

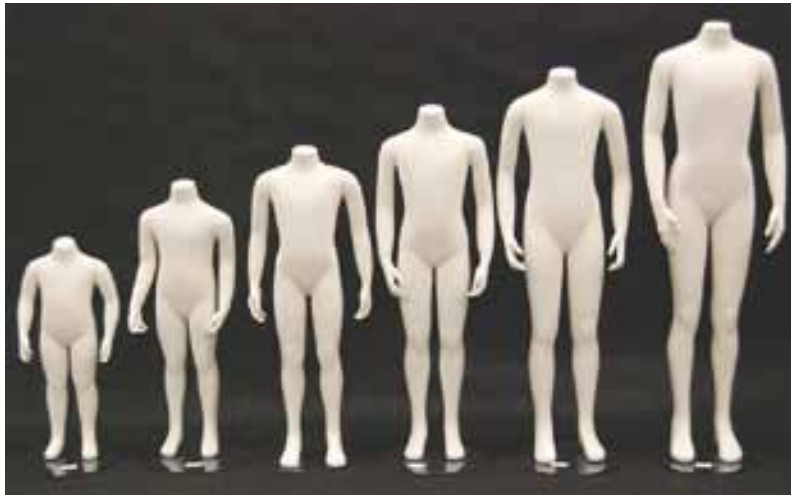

KID4NH KID6STNH KID6NH KID8NH KID10NH KID12NH

## KID8NH

8 year old, Size 8  
Height: 45-1/2"  
Chest: 24-1/2"  
Waist: 21"  
Hips: 26"

## KID10NH

10 year old, Size 10  
Height: 50"  
Chest: 26-1/2"  
Waist: 22-1/2"  
Hips: 29"

## KID12NH

12 year old, Size 12  
Height: 54-3/4"  
Chest: 30"  
Waist: 22-1/2"  
Hips: 32"

## CHO9Y

## CHO7Y

## CHO5Y

## CHO3Y

## CHO1Y

# SOFTIES

- All Softies pricing includes attached heads and neck caps so either can be displayed.
- Softies are totally flexible.
- Covered in creme color Jersey.
- Satin chrome square metal base and neck cap.
- Base fits into heel on all models except CHO6 and CHO3 which has base fittings in the calf.

All flexible Softies include head and neck caps for your display. CHO6 and CHO3 only comes with neck cap.



CHO6

CHO3

## Height

CHO3	Flexible 3 mo.	19
CHO6	Flexible 6 mo.	26
CHO1Y	Flexible 1 yr. old	31
CHO3Y	Flexible 3 yr. old	37
CHO5Y	Flexible 5 yr. old	42
CHO7Y	Flexible 7 yr. old	47
CHO9Y	Flexible 9 yr. old	57

# HOSIERY LEGS

## WOMEN'S HOSIERY FORMS



W47 – Hip Hi Leg  
 W44 – Thigh Hi  
 W432 – Knee Plus  
 W43 – Knee Hi  
 W41 – Calf Hi

W47 W44 W432 W43 W41

## CHILDREN'S HOSIERY FORMS



G23 – Knee Hi  
 G22 – Calf Hi  
 G21 – Crew  
 G20 – Ankle

G23 G22 G21 G20



## MEN'S HOSE FORMS

M34 – Knee Hi  
 M32 – Calf Hi  
 M31 – Lo Calf

M34 M32 M31

All Hosiery Legs Have  
 Extra Heavy Weighted  
 Toes for Stability

## EYEGLOSS DISPLAY



### EYEGLOSS DISPLAY

FOR SLATWALL OR FREE-STANDING

Hang from Slatwall (hooks included) or stand on counter.

SINGLE HEAD

TRIPLE HEAD

SHM – Male

THM – Male

SHF – Female

THF – Female

## STYROFOAM BOOT FORM



14" high  
 to fill out  
 boots for  
 display,  
 white.

595  
 Boot Form

## GLOVE HANDS



Made of  
 fleshtone color  
 vinyl with  
 decorative  
 cuffs. Won't  
 peel, crack,  
 fade or chip.

G7/L G7/R

G4/R G4/L

Mens – 12" high

Ladies – 12" high

G7/L – left

G4/L – left

G7/R – right

G4/R – right

# HEADS

Great for display of hats, wigs, glasses, etc.

## STYROFOAM MILLINERY DISPLAY HEADS



FIBERGLASS  
 MILLINERY HEADS

### FIBERGLASS MILLINERY HEADS

WH20 - Woman's - 20" high

WH24 - Men's - 24" high

WH20

WH24



Pinable For Easy Fitting  
 White Color

6258K - Male - 12" high

6354X - Unisex - 15" high

6258K  
 Male

6354X  
 Unisex



# ECONOLINE SHOWCASES & COUNTERS

Create your own layout with these fabulous counters & showcases. All units are made of 3/4" thick MDF board covered with your choice of light grey, black, white, walnut or maple laminate. Interior surfaces are white. Layout illustrated below is typical of what you can do with components shown on this page. Tempered glass used on showcases. All prices this page are F.O.B. N.J. All showcases are shipped freight.

## L SHAPE COMBINATION

- A. Choice of 48", 60", or 70" Showcase
- B. Pentagon Corner
- C. Well-Top Register Stand
- D. Wrap Counter



## FULL VISION SHOWCASES

38" high x 18" deep with 3/4" thick panels. Two glass shelves 1-8" and 1-10" deep. 25" high front glass, tempered glass top. Satin aluminum frame, chrome standards and brackets. White door and interior. 48", 60" or 70" showcases. Prices below are for set up showcases.

48" Long	60" Long	70" Long
9000AW - White	9000BW - White	9000CW - White
9000AB - Black	9000BB - Black	9000CB - Black
9000AM - Maple	9000BM - Maple	9000CM - Maple
9000AWL - Cherry	9000BWL - Cherry	9000CWL - Cherry



### OPTIONAL FEATURES FOR SHOWCASE

- LK1 - Locks
- LD - L.E.D. Light, 48" L
- LD2 - L.E.D. Light, 60" L
- LD3 - L.E.D. Light, 72" L



### CORNER PENTAGON FILLER

Creates a 90" corner, 38" high x 18" deep x 18" long. 2 adjustable glass shelves.

- PC18W - White
- PC18B - Black
- PC18M - Maple
- PC18WL - Cherry



### WELL-TOP REGISTER STAND SHOWCASE

38" high x 18" deep x 24" long. Shelves in front.

- RC0W - White
- RC0B - Black
- RC0M - Maple
- RC0WL - Cherry



### WELL-TOP REGISTER STAND

38" high x 18" deep x 24" long. Adjustable rear shelf and 1 drawer. Solid wood front.

- 9182W - White
- 9182B - Black
- 9182M - Maple
- 9182WL - Cherry



### WRAP COUNTERS

Adjustable bag bins and one adjustable 3/4" wood shelf in rear. Counter height is 38," width is 24", 3 lengths.

48" LONG	70" LONG
W464W - White	W466W - White
W464B - Black	W466B - Black
W464M - Maple	W466M - Maple
W464WL - Cherry	W466WL - Cherry

All items this page are set up as pictured and shipped freight. Items are also available knocked down flat at lower prices.

**Deduct \$65.00 off of pricing for knocked down Showcases and Wrap Counters.**

**Deduct \$40.00 from prices on Register Stands and Fillers.**

**Combine Showcases, Registers, and Wrap Counters for quantity prices.**

**\$35.00 Crating Charge for all set-up items shipped freight.**

# ECONOLINE LEDGE TOP CHECKOUT COUNTERS



18" deep body x 22" deep top with 9" deep ledge. 42" high. Counter has 1 drawer and 2 adjustable shelves. 48" or 72" wide.



## Slatwall Front Counter

18" deep body x 22" deep top with 9" deep ledge. 4" recessed slatwall front. 42" high. Counter has 1 drawer and 2 adjustable shelves. 48" or 72" wide.

LTC48W..... White..... 48" wide  
LTC48B..... Black..... 48" wide  
LTC48M..... Maple..... 48" wide  
LTC48C..... Cherry..... 48" wide  
LTC72B..... Black..... 72" wide  
LTC72M..... Maple..... 72" wide

LTS48B..... Black..... 48" wide  
LTS48M..... Maple..... 48" wide  
LTS48C..... Cherry..... 48" wide  
LTS72B..... Black..... 72" wide  
LTS72M..... Maple..... 72" wide

**All ledge top checkout counters are shipped K.D. Flat.  
Add \$65.00 to price to set up units.**

# TOP OF THE LINE EXTRA VISION SHOWCASES

- 4" kickplate with 32" high display area
- Rear sliding doors
- Aluminum frame
- Includes one 8" deep glass shelf and one 10" deep shelf

**All units are set-up. \$35.00 crating charge for freight shipments.**



## SHOWCASES

38" High x 20" Deep  
SEV36P..... 36" L..... White Panel Doors  
SEV48P..... 48" L..... White Panel Doors  
SEV60P..... 60" L..... White Panel Doors  
SEV70P..... 70" L..... White Panel Doors  
SEV36M..... 36" L..... Mirrored Doors  
SEV48M..... 48" L..... Mirrored Doors  
SEV60M..... 60" L..... Mirrored Doors  
SEV70M..... 70" L..... Mirrored Doors



## OPTIONAL ACCESSORIES

EV509... Lock  
EV502... Fluorescent light strip  
LD..... L.E.D. Light

## BACK OPENING OUTSIDE CORNER CASES

38" High x 20" Deep  
SEVBOC34P.....34" L..... White Panel Doors  
SEVBOC42P.....42" L..... White Panel Doors  
SEVBOC51P.....51" L..... White Panel Doors  
SEVBOC34M.....34" L..... Mirrored Doors  
SEVBOC42M.....42" L..... Mirrored Doors  
SEVBOC51M.....51" L..... Mirrored Doors



## CORNER COMBINATION

38" High x 20" Deep  
SEVCC68P.....48" L..... White Panel Doors  
SEVCC80P.....60" L..... White Panel Doors  
SEVCC68M.....48" L..... Mirrored Doors  
SEVCC80M.....60" L..... Mirrored Doors



## BACK OPENING INSIDE CORNER CASES

38" High x 20" Deep  
SEVBIC34P.....34" L..... White Panel Doors  
SEVBIC42P.....42" L..... White Panel Doors  
SEVBIC51P.....51" L..... White Panel Doors  
SEVBIC34M.....34" L..... Mirrored Doors  
SEVBIC42M.....42" L..... Mirrored Doors  
SEVBIC51M.....51" L..... Mirrored Doors

*Also available: Jewelry Showcases, Wall Cases.  
Call for our extensive showcase color catalog.*

## PLASTIC CLIPS

Keep your garments displayed properly with these handy clips.

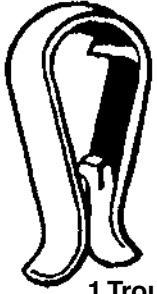

1 Trouser



72 Queen



14JC

**1 Trouser** – White, Secures suits or dress pants to wooden or plastic hangers

**72 Queen** – Natural color, Holds slacks in place over hanger

**14JC** – Elastic attached to 2 large clips. Ties back garment for better presentation

## SHIRT FOLDING HELPER

For Children's, Men's & Ladies'

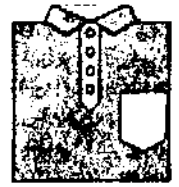
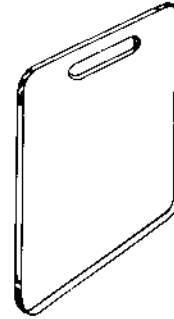

**Saves Time... Money!!**

Fold shirts around board and remove – Makes for neat stacks of shirts or sweaters.

Made of 1/8" clear acrylic.

Hand slot for easy use.

**130J** – Ladies' Sizes, 10" x 12"

**130M** – Men's Sizes, 11" x 12"

**130K** – Kid's Sizes, 8 1/2" x 11"

## GARBAGE BAGS

Available in Black or Clear

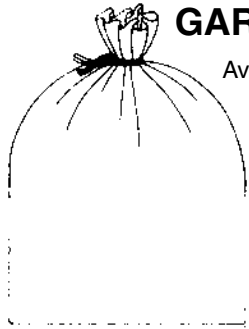

**Style 306L**

30 Gallon Capacity

**306LB** – Black

**306LC** – Clear

## CLEVER CLIP

Twist it, Turn it,  
Hook it & Hang it,  
2" high,  
Black Color.



06-6710B – Black

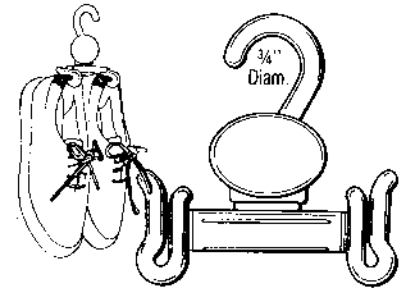

## SHOE HANGER

For Display of Shoes & Sneakers

**ID156W** - Natural

**ID156B** - Black

## PLASTIC PENNANTS

PLP080

Great for grand opening or special events. The most economical and colorful outdoor decoration you can buy. 24 pennants, each 12" x 18". On a 60 foot plastic rope.

**Red, Blue, Yellow, Purple, Green, Orange Pennants.**

PLP080 –

## INVISIBLE WIRE

Jumbo 1100 foot spool of dark 32 gauge wire. Great for hanging displays from ceiling or in your display windows.

WR32



## TRACK-HOOK

**Lexan Ceiling Hook**

Lexan Track Hook Crystal Clear. Swings open to lock securely on T-Bar or Suspended Ceiling.

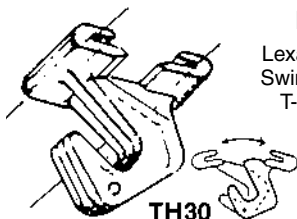

TH30

TH30

## CEILING CLIP

**CC12** –  
2-3/4" long

Squeeze and attach to grid or your drop ceiling. Combine with invisible wire for hanging displays throughout your store.



CC12

# BEAUTIFUL CHROME COUNTER FIXTURES

SKILLFULLY CRAFTED WITH BALANCE AND BEAUTY IN MIND

## REVOLVING DISPLAYERS

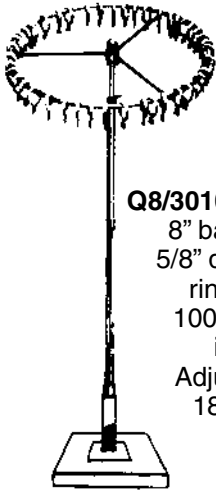

**Q8/3010 – Scarf Stand**  
8" base, 14" dia.,  
5/8" dia. extension,  
ring revolves,  
100 plastic clips  
included,  
Adjustable from  
18" up to 36"

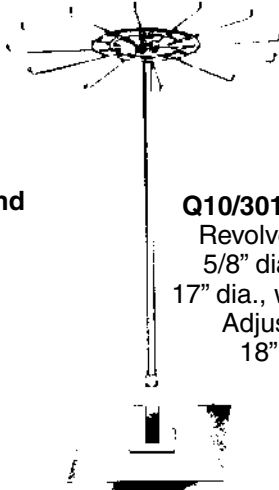

**Q10/3012 – Tie Stand**  
Revolves, 10" base,  
5/8" dia. extension,  
17" dia., with 12 spokes,  
Adjustable from  
18" up to 36"

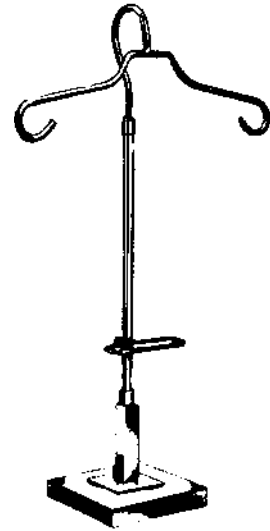

**Q6/1814 – Gooseneck Blouse  
Displayer with Waist Clincher**  
6" base, 5/8" dia. extension,  
Adjustable from 18" up to 36"



**Q6/1810 – Hook Stand**  
Great for  
Window Display  
6" base,  
5/8" dia. extension,  
Adjustable from  
18" up to 36"

## MIRROR

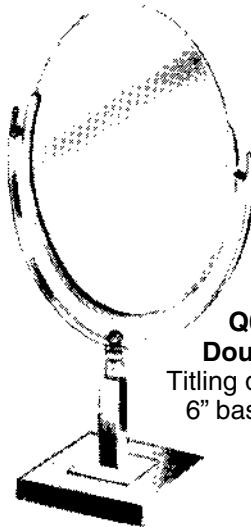

**Q6/1014 – Oval  
Double Face Mirror**  
Tilting double faced mirror,  
6" base, 10 x 14" mirror



**Q6/1016 – Double Sided  
Rectangle Mirror.**  
6" base, 10" x 12" mirror.

# JEWELRY DISPLAYERS

Attractive displays and trays at prices you won't want to pass up. Displays are made of thick cardboard covered in black Flockboard. Made with easels or metal stands as shown. Other colors & styles are available. We will be happy to send our full jewelry display catalogue on request, free.

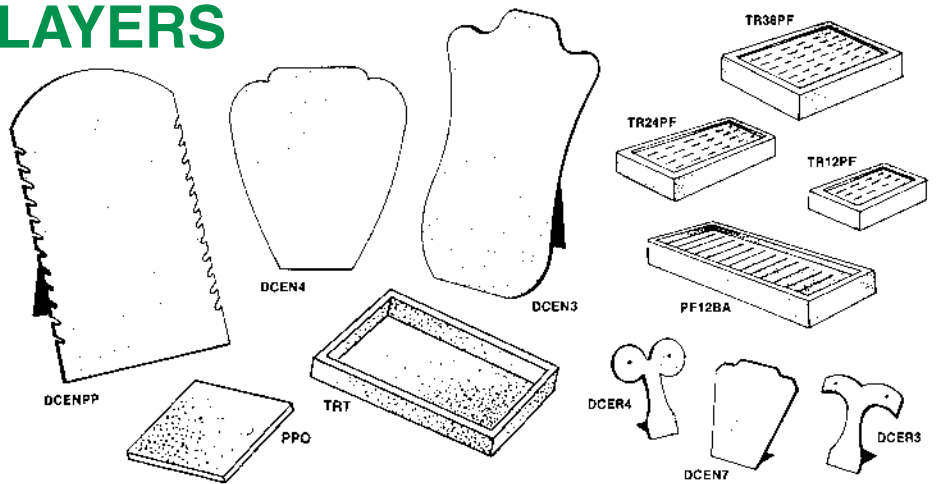

STYLE	STAND	DESCRIPTION	SIZE
DCENPP	*	12 Necklace Displayer	7-1/2"W x 14"H
DCEN4	*	Necklace Displayer	7-1/8"W x 8-3/8"H
DCEN3	*	Necklace Displayer	7-3/4"W x 14"H
TR12PF		12 Ring Displayer	5-7/8" x 3-3/4" x 1"
TR24PF		24 Ring Displayer	8-1/4" x 4-3/4" x 1"
TR36PF		36 Ring Displayer	8-1/4" x 7-1/4" x 1"
PF12BA		24 Bangle Tray	4" x 14" x 1"
DCER4	**	Earring Display	3" x 4"H
DCEN7	**	Pendant	3" x 3-3/4"
DCER3	**	Earring	3-3/8" x 4"
F1M		Ring Display	2-1/8" x 2-1/8" x 1-3/8"H
ER3		Earring Display	4-1/4"H
ER1		Earring Display	4-3/4"H
PPO		Velvet Pad	7-5/8" x 7-1/2"
TRT		Utility Tray	14-3/4" x 8-1/4" x 1"

\* Cardboard Easel

\*\* Metal Stand

All jewelry displayers are heavy duty cardboard covered with black Flockboard. Other colors on request only.

**Combine Items for Quantity Pricing**

# JEWELRY CASES & DISPLAYERS

## NECKLACE T-BAR

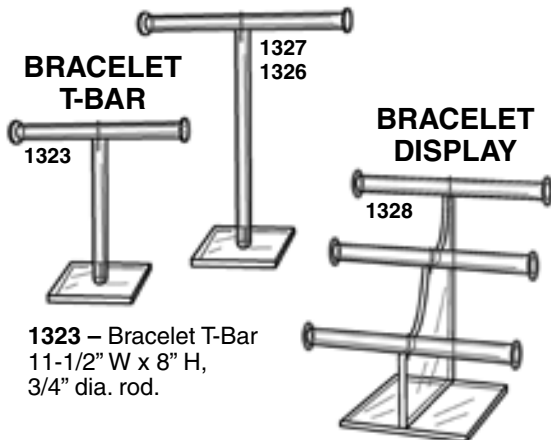

**1323** – Bracelet T-Bar  
11-1/2" W x 8" H,  
3/4" dia. rod.

**1327** – Necklace T-Bar  
15-1/2" W x 15" H,  
1" dia. rod.

**1326** – Necklace T-Bar  
15-1/2" W x 18" H,  
1" dia. rod.

**1328** –  
Bracelet Displayer  
11-1/2" W x 13 H.

## ROTATING EARRING/PIN DISPLAY

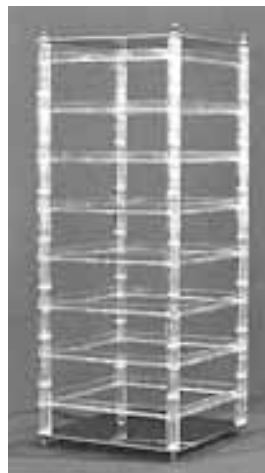

### ACRYLIC COUNTER EARRING DISPLAYER, REVOLVING

**S08** – 8" x 8" x 21" high. 8 tier. Holds 128 sets of earrings.

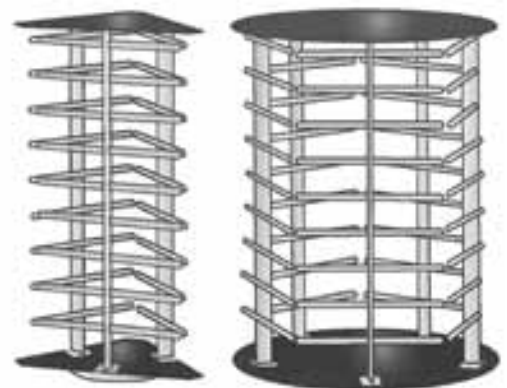

**1376**

**1379**

**1376** – Clear crossbars with black acrylic base. Maximum 108 2" cards. 19-1/2" H.

**1379** – For carded earrings or pins. Maximum 180 2" cards. 19-1/2" H.



# SALES AIDS



## SHOE FITTING STOOL

**SHF30**

Shoe Fitting Stool. Has a black padded seat. Black or Chrome metal.

**SHF30C – Chrome**

**SHF30B – Black**



## SHOE BENCH

Bench with 2 Mirrors.

Chrome legs with bench seat.  
**504TFS 19"H x 30"W x 14"D**



## SCARF CLIPS

**SCL** – Place clips over display ring, twist legs and squeeze. Presto! It's that simple to hang scarves! Black plastic.

## DISPOSABLE NYLON FOOT SOX



**Style 2413** – Woman's, neutral color.

**Style 2316** – Men's, black color



## HOSIERY HANGERS

**COLOR:** Black,  
3-1/2" long

**HOS**



## SUCTION CUP HOOK

1-5/8" dia. suction cup attaches to glass or any smooth surface.

**MC/LC**

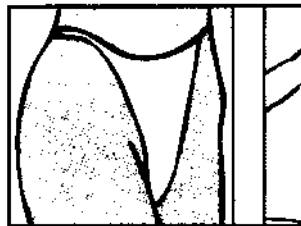

## POLY FIBER SANITARY CLOTHING PROTECTOR

*Protects Your Bathing Suits.*

**SP4**

# STORE NECESSITIES

## SALES BOOKS

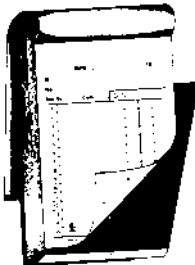

3 3/8" x 5 1/2" long  
Numbered in sequence  
50 duplicate sets  
White paper

**12A –  
SALES BOOKS**

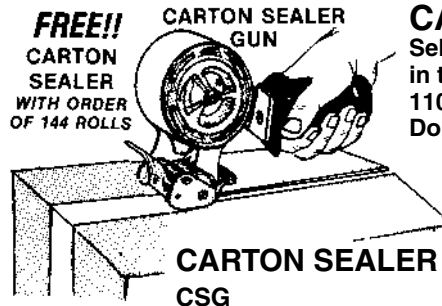

**FREE!!**  
**CARTON SEALER**  
**WITH ORDER**  
**OF 144 ROLLS**

**CARTON SEALER GUN**

**CARTON SEALER  
CSG**

## CARTON SEALING TAPE

Self-Adhesive Sealing Tape. Available in tan or clear. 2" wide.

110 yards on a roll.

Double roll.

**110 YARD**

**PVC-1 – TAN TAPE**

**PVC-2 – CLEAR TAPE**

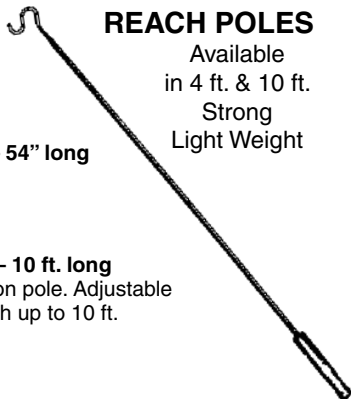

## REACH POLES

Available  
in 4 ft. & 10 ft.  
Strong  
Light Weight

**LIFT1– 54" long**

**LIFT2 – 10 ft. long**  
3 section pole. Adjustable  
in length up to 10 ft.



**HEAVY DUTY  
STAPLE GUN TACKER**  
*SHOOTS A STAPLE  
WHEREVER YOU'D  
DRIVE A NAIL!*

• **FASTER • CHEAPER**  
• **BETTER**

**T30 – Staple Gun**  
**T30M – 1/4" Staples**

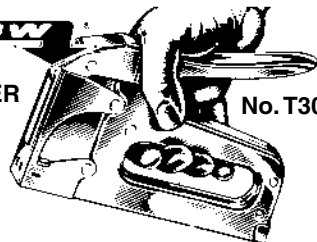

**No. T30**



## UTILITY BLADE

**MODEL C** – Rugged fully retractable all purpose utility cutter.

# SIZE MARKING SYSTEMS

The easy way to size your garments. All markers slip over the hook of the hangers to show the size of the garment. Full size range available on Regular Markers (MB), Mini-Markers (MIB). Sale and Percentage Off markers also available. (Custom Colors Available — Call for Volume Pricing.)

## Standard Marker



**MB — SIZE MARKER**  
**MMB — BLANK MARKER**

**MB — OUR MOST POPULAR MARKER**  
Size Printed Black on White Marker. Stock color identification system available.

◀ (Regular Marker with Size)

**MMB — Regular marker blank** available in the following colors: White, Yellow, Blue, Dk. Blue, Red, Dk. Red, Black, Brown, Green, Orange, Pink and Beige.

## MINI — MARKERS

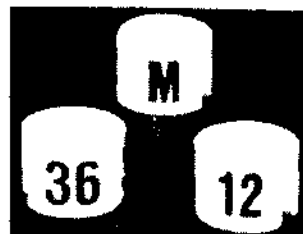

**MIB — Mini Size Marker**  
**MIBB — Mini Blank Marker**

**MIB — Mini Markers** are mainly used with shipping hangers. Black print on white marker.

**MIBB — Mini Blank Markers.** Same selection of colors as MMB.

Orders should be in multiples of 50 Per Size.

(Minimum 100 Per Bag)

# SELF ADHESIVE SIZE STICKERS

HIGH VISIBILITY STICKERS TO ORGANIZE YOUR INVENTORY!!

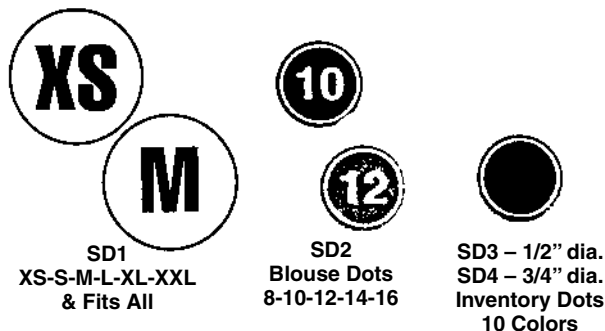

## SIZE DOTS

- SD1** — 3/4" diameter clear adhesive dots. (1000 per box) Sizes: XS-S-M-L-XL-XXL-Fits All
- SD2** — 1/2" diameter adhesive color coded blouse dots. (1000 per box) Sizes: 8-10-12-14-16
- SD3** — 1/2" diameter adhesive color coded inventory dots. (1000 per box)
- SD4** — 3/4" diameter adhesive color coded inventory dots. (1000 per box)  
Colors for SD3, SD4: blue, yellow, red, green, black, purple, grey, mauve, gold, silver  
Packed: 1000 per roll in dispenser box.  
Combine SD1, SD2, SD3, SD4 for quantity pricing.

**SD1 & SD4** (1,000 per box)      **SD2 & SD3** (1,000 per box)

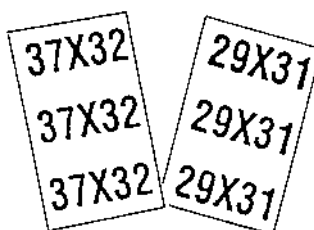

**HSS**

## HEM SIZE STICKERS

**HSS** — Sticker is 1-1/4" wide x 5" long, size is written 9 times on each sticker. Clear sticker with black print. Great for marking pants. Use size grid below when ordering. 250, 1-1/4" x 5" long stickers on each roll. Combine sizes for quantity pricing.

WAIST →	24	26	27	28	29	30	31	32	33	34	35	36	37	38	40	42	44
LENGTH ↓																	
↓	X																
28																	
29																	
30																	
32																	
34																	
36																	
38																	
WAIST ONLY																	

# SECURITY CENTER

SC2010

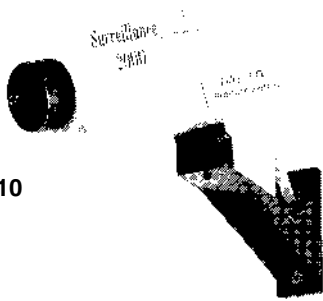

## SIMULATED SECURITY CAMERA

- Price breakthrough
- Adjustable swivel bracket
- Blinking red light
- Warning decals included
- Molded ABS plastic
- Uses 2 C-cell Batteries

## SECURITY CHAIN, RING AND LOCK

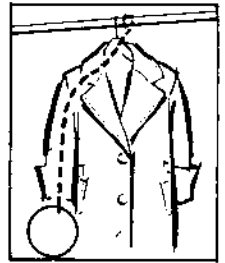
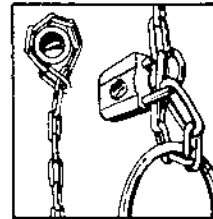

Chain, ring and lock protects expensive clothing from theft. Chain loops around hangrod, passes thru sleeve and locks to large ring. Kit includes 45" chain, 8" diameter ring, lock and key.

**Style CRL** – Chain, Ring, Standard Lock Kit

## CONVEX MIRROR

Hang from walls, ceiling or corners for those hard-to-see areas in your store. A real theft preventer. All steel construction, wide sweeping 160 degree view. Available in six popular sizes.

- CC18** – 18" Diameter
- CC24** – 24" Diameter
- CC32** – 32" Diameter

**CONVEX SECURITY MIRROR**

Shipped UPS

## COUNTERFEIT MONEY DETECTOR



**Style MP1**

**Amber Color Means Bill is Genuine. Dark Color Means Bill is Suspect!**

## BASKETS ON WHEELS



Inexpensive all plastic shopping basket on wheels with a 21-1/2" fully extendable pull handle which folds down when not in use. Shopping basket is 18-3/4" long x 13-1/4" wide x 12-1/4" high. The unit has 1" wheels for easy movement. Customers can load in multiple items to bring to checkout. Available in Green, Blue, Red and Yellow. 6 per box.

- BKT811GN** – Green
- BKT811BU** – Blue
- BKT811RD** – Red
- BKT811YL** – Yellow

## SHOPPING CARTS

**Standard Medium Size Metal Shopping Cart**



Heavy Duty Wheels  
Silvervein Finish  
22" Wide,  
40-1/2" High,  
38" Long.

**Truck Shipments Only**

**S89** – Silvervein



**Wire Frame Basket Holder**

**BKTH67**

## SHOPPING BASKETS

Handy baskets allow your customers to carry more easily. Available with or without your logo.

Americana Basket has double black plastic spring loaded handles that snap back into place when not in use. 12" wide x 18" long x 8-1/2" deep heavy duty construction. Metal handles.

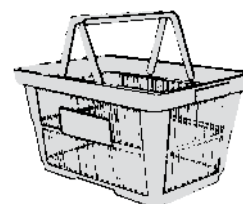

No Minimum

- BKT6** – Red
- BKT7** – Blue

**NEW  
COLORS  
AVAILABLE**

# UNBREAKABLE PLASTIC SIZE DIVIDERS

Numbered 1-60, S-M-L-XL-XXL 1/2 sizes etc.

The strongest, longest lasting, easiest to read plastic dividers! With big, bold numbers on both sides that can't fade, smear or rub off!! Unbreakable, fits any diameter hangrod, can't fall off!

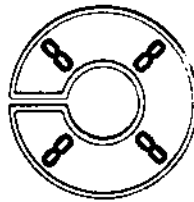
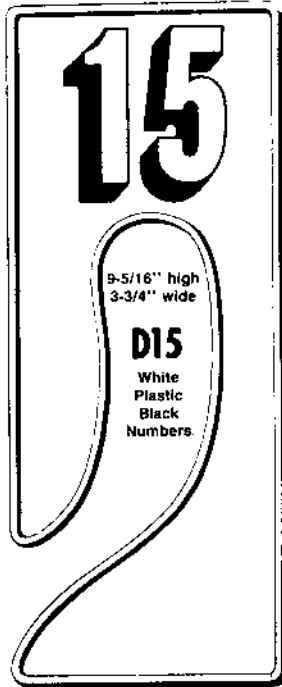

**D2 - ROUND**

D2 - White with black numbers

**D2 & D2G  
Are  
3 1/2" in Diameter**



**D2G - BLACK**

D2G - Black with gold numbers

D3 - Alphabet A-Z  
D4 - Day of the Week

## COLORS AVAILABLE

**D2 Model Only**

Lt. Blue, Sun Yellow, Magenta, Lt. Green, Dk. Green, Orange, Bright Red. Printed in black or white.  
Minimum 100 per lot.

## KING SIZE DIVIDERS

D15 - Sizes 1-60, Half Petite Sizes and Blanks  
\$.60 (under 100 pcs. mixed sizes)  
\$.56 (over 100 pcs. mixed sizes)  
\$.54 (over 100 pcs. per size)

D16 - Alphabet  
D17 - Days of Week

## QUEEN SIZE DIVIDERS

2" Wide x 5" Long

D1 - White Divider with Black Print  
2" Wide x 5" Long

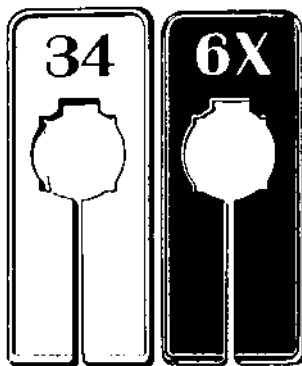

D1G - Black Divider with Gold Print  
2" Wide x 5" Long

D1A - White Divider with Black Print, Alphabet  
D1D - White Divider with Black Print, Days of Week

## FITTING ROOM CHECKS

2" Wide x 5" Long

**Stop The Thief In Your Fitting Room!**

Customer gets check to match number of garments, up to 6.

M320 - Kit of 100 Pieces  
(25 of Guest, 1, 2, 3)

M319 - Package of 30 Pieces  
(10 ea. 4, 5, 6)

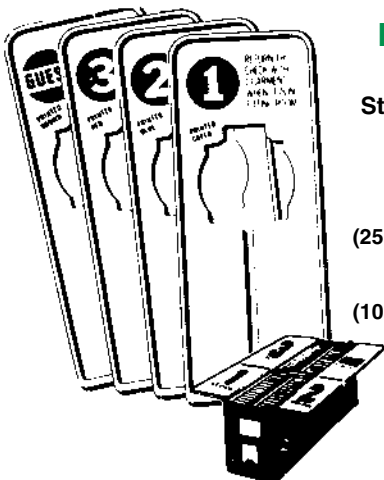

**ORDER FORM** Avoid errors on Mail & Phone Orders! Organize your needs by first checking Style of Dividers wanted & then filling in quantity desired of each Size.

### KING SIZE DIVIDERS

D15 Black on White

### ROUND SIZE DIVIDERS

D2 Black on White  
 D2G Gold on Black

### QUEEN SIZE DIVIDERS

D1 Black on White  
 D1G Gold on Black

0	1	1X	2	2X	3	3X	4	4X	5
6	6X	6 1/2	7	8	8 1/2	9	10	10 1/2	11
12	12 1/2	13	14	14 1/2	15	15 1/2	16	16 1/2	17
17 1/2	18	18 1/2	19	20	20 1/2	21	22	22 1/2	23
24	24 1/2	25	26	26 1/2	27	28	28 1/2	29	30
30 1/2	31	32	32 1/2	33	34	35	36	37	38
39	40	41	42	43	44	45	46	47	48
49	50	51	52	53	54	55	56	57	58
59	60	Small	Medium	Large	XS	XL	XXL	XXXL	XXXXL
Petite	Newborn	Infant	Toddler	Regular	Husky	Slim	Tall	Short	Average
Long	3P	4P	5P	6P	7P	8P	9P	10P	11P
12P	13P	14P	15P	16P	17P	18P	20P	3-4	5-6
7-8	9-10	11-12	13-14	15-16	17-18	3 Mo.	6 Mo.	9 Mo.	12 Mo.
18 Mo.	24 Mo.	30 Mo.	36 Mo.	1T	2T	3T	4T	Blank	



# DENNISON PRICE MARKING GUNS

## Model 106 Hand Labeler

Single line print display. 6 digits on 1 line. (5 or 8 digit models also available.) Easy to load, easy to set and easy to use.

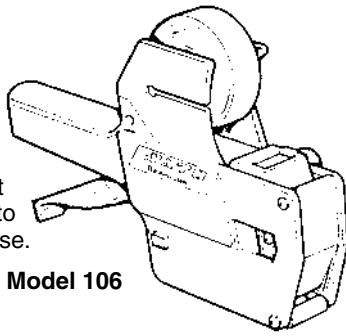

Model 106

**L21 – Self-Stick Blank Labels** – For Model 106  
1,000 per roll  
9,000 per package

**\$19<sup>99</sup>**

Actual Size For Model 106

**106INK – Replacement Ink**

## Model 216 Hand Labeler

Double Line Display. 8 digits on 2 lines. Highly readable.

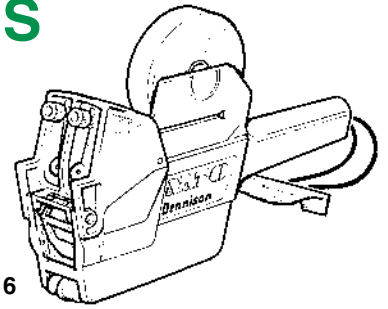

Model 216

**L56 – Self-Stick Blank Labels** – For Model 216  
1,250 per roll  
12,500 per package

**\$19<sup>99</sup>**

**216INK – Replacement Ink**

**L56RP – Self-Stick Labels** – For Model 216  
1,250 per roll  
12,500 per package

REG. PRICE ~~\$17.99~~  
OUR PRICE **\$9.99**

Sticker says: Reg Price / Our Price

# TAGGING GUNS & NEEDLES

Guns shoot standard plastic fasteners through hole in tag right into garment – without damage. Load the cartridge of shoot-on fasteners and bang-bang-bang! Tags are attached permanently and securely until cut loose. Greatest time-saver ever invented. Hangs tags neat and orderly where you want them. Eliminates tag switching – gets merchandise out on the selling floor faster. Combine with stringless tags (see pages 92 and 93). The three guns on this page use standard fasteners (see page 89: PF1 – 1” long, PF2 – 2” long, PF3 – 3” long, or PFH – hooks).

**PAT38 TAGGING GUN**



## PATRIOT TAGGING GUN

**PAT38** – Industrial quality gun.  
**PAT38** – Patriot Gun

**PGN** – Replacement Needle. For Patriot Gun only.

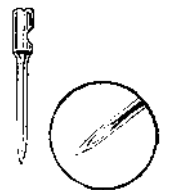

Special tip separates instead of tearing garment.

**RC1** – Replacement Cutter

**ARO38 ARROW TAGGING GUN**



## ARROW TAGGING GUN

**ARO38** – Uses standard TGN Needle and standard fasteners on next page. A proven gun that holds up over time.

**TGN** – Standard Gun Replacement Needle. For use with ARO38, or G38.

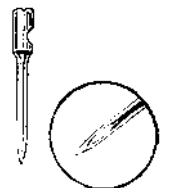

Special tip separates instead of tearing garment.

**RC1** – Replacement Cutter

**G38 STANDARD TAG GUN**



## STANDARD TAGGING GUN

**G38** – A proven tag gun! Uses TGN standard needles and all standard fasteners.

**G38** – Standard Tag Gun



# "SHOOT ON" CLEAR FASTENERS

Also available in Green, Blue, Black, Red and Yellow.

For use with tagging guns SIM38, ARO38 or G38.

UNIVERSALLY ACCEPTED BY ANY GUN ON THE MARKET.

The best fasteners on the market today!! These fasteners fit any tag gun available today. They refuse to clog your gun!! Improved technology makes possible these new lower prices!! Clear fasteners in 1" (PF1), 2" (PF2), or 3" (PF3) lengths at the same price. The 3" size is most popular. They are packed 5000 per box. 50 fasteners per load.

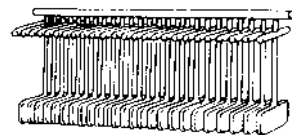
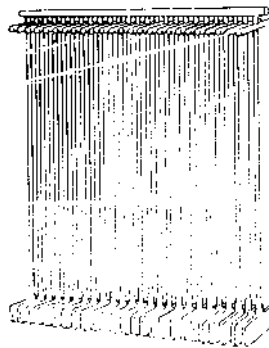

Please Specify:

PF1 - 1" long

PF2 - 2" long

PF3 - 3" long

(Packed 5000 per box)

Prices are for clear fasteners. For color fasteners, add \$.75 per box.

## CLEAR SHOOT ON HANGER HOOKS



The easiest and quickest way to hang gloves, socks, ties, belts, scarves. Great for hanging on pegboard hooks, Slatwall or Gridwall hooks. For use with tagging guns ARO38, SIM38 or G38. Also, available in variety of colors.

Style PFH - 1-3/4" long  
(Packed 5000 per box)

Prices are for clear fasteners. For color fasteners, add \$1.00 per box.

## FINE FASTENER SYSTEM

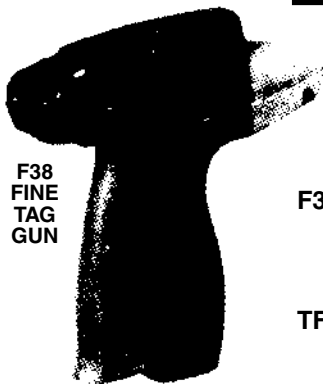

F38  
FINE  
TAG  
GUN

Some customers prefer to use our Fine Tach-It Gun with delicate fabrics, silks, etc. Needle used in the fine gun leaves a smaller hole in the garment than the G38 Gun. Fine barbs are available in 1" (FB1), 2" (FB2), or 3" (FB3). Please Specify!! F38 Gun will work with fine barbs only.

F38 - Fine Needle Tach-It Gun

### FINE FASTENERS

Fine Barbs: FB1 (1"), FB2 (2"), FB3 (3")

TFN - Fine Needle (Replacement)

*Fine Barbs can only be used with Fine Gun*

## DENNISON SYSTEM 1000 FASTENER SYSTEM

THE FASTEST TAG ATTACHING SYSTEM IN THE INDUSTRY

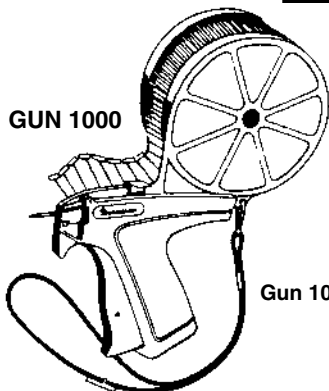

GUN 1000

Gun 1000

### GUN 1000 TAG GUN

- Increases productivity. Gun 1000 holds 1000 barbs at a time.
- Operator would normally reload 20 times with a regular gun. Only one time with GUN 1000!

Replacement Needle  
G1000N



PF1000  
GUN 1000 FASTENERS

2-1/2" long, natural color, 1000 fasteners per roll. Slips right into gun. 5000 per box.

PF1000

FOR DIFFICULT TO MARK ITEMS USE

## SECUR-A-TACH

Clear "Snap On" fasteners. Push ends together... will never come apart.

Ideal for hundreds of purposes - tagging of handbags, tennis racquets, belts, bicycles, skis, or to keep pairs of shoes or sneakers together. Available in 3 different sizes.

103F - 3" long

105F - 5" long

109F - 9" long

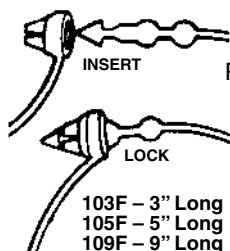

103F - 3" Long  
105F - 5" Long  
109F - 9" Long

5,000 per box

## CABLE LOCK

8" long heavy duty nylon cable lock. Use cable locks to lock hangers to racks. Tightens to fit. Black or White.

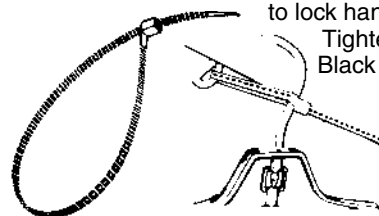

CL8 - Black  
CL8W - White

# LAY-AWAY, ALTERATION & REPAIR TAGS

**ALTERATION**  
No. \_\_\_\_\_  
Date \_\_\_\_\_ 19\_\_\_\_  
Name \_\_\_\_\_  
Address \_\_\_\_\_  
Garment \_\_\_\_\_  
Salesperson \_\_\_\_\_ Dept. \_\_\_\_\_  
Will Call \_\_\_\_\_ Send \_\_\_\_\_  
CHARGE  CASH  C.O.D. \_\_\_\_\_  
Amount of Sale \_\_\_\_\_  
Tax \_\_\_\_\_  
Alteration Charge \_\_\_\_\_  
Total \_\_\_\_\_  
Deposit \_\_\_\_\_  
Balance Due \_\_\_\_\_  
NOTE ALTERATIONS ON REVERSE SIDE

**CUSTOMER'S CLAIM CHECK**  
No. \_\_\_\_\_ Amt. of Sale \_\_\_\_\_  
To Be Ready  
 A.M.  P.M.  
Tax \_\_\_\_\_  
Alt. Chge. \_\_\_\_\_  
Total \_\_\_\_\_  
Deposit \_\_\_\_\_  
Balance Due \_\_\_\_\_  
Salesperson \_\_\_\_\_  
NO GARMENTS DELIVERED WITHOUT THIS CHECK

**LAY-AWAY**  
NAME \_\_\_\_\_  
ARTICLE \_\_\_\_\_  
ADDRESS \_\_\_\_\_  
NAME \_\_\_\_\_  
ADDRESS \_\_\_\_\_  
ARTICLE \_\_\_\_\_ S. P. \_\_\_\_\_ LOT No. \_\_\_\_\_  
PRICE \_\_\_\_\_ DATE \_\_\_\_\_ PAYMENTS \_\_\_\_\_ BALANCE \_\_\_\_\_  
TAX \_\_\_\_\_  
TOTAL \_\_\_\_\_  
DEPT. No. \_\_\_\_\_

**No. T1002** – Two Section Alternating String Tab. 6-1/8" x 3-1/8" printed black on manilla. Consecutive numbers in red. 500 per box.

**No. T2001** – Three Section Layaway String Tab. 6-1/8" x 3-1/8" printed black on manilla. Consecutive numbers in red. 500 per box.

**Back of TL201 TICKET**

LOT NO. \_\_\_\_\_  
DATE RECD. \_\_\_\_\_  
LAST PAYMENT DUE \_\_\_\_\_

REMARKS:

**PAYMENTS MADE**

Date	Sale Slip Number	Amount Paid	Balance Due

PLEASE RETAIN THIS IDENTIFICATION STUB WITH MERCHANDISE. RETURN ALL SALES SLIPS AND RECEIPTS.

**LAY-AWAY TICKET No.**

Date \_\_\_\_\_  
Name \_\_\_\_\_  
Address \_\_\_\_\_  
Description of Merchandise \_\_\_\_\_  
Sold By \_\_\_\_\_ Retail Price \$ \_\_\_\_\_  
The stick together with Identification 5-8 to be used in Office when merchandise is called up by customer.

**STORE RECORD OF PAYMENTS**  
TICKET NO. \_\_\_\_\_ Retail Price \$ \_\_\_\_\_

Name \_\_\_\_\_  
Address \_\_\_\_\_  
Description of Merchandise \_\_\_\_\_ Clerk No. \_\_\_\_\_

**PAYMENTS MADE**

Date	Sale Slip Number	Amount Paid	Balance Due	Paid to By Clerk No.

**CUSTOMER'S IDENTIFICATION STUB**  
**LAY-AWAY TICKET No.**  
THIS STUB TO BE RETAINED FOR IDENTIFICATION PURPOSES UNTIL FINAL PAYMENT IS MADE BUT MUST BE SURRENDERED UPON RECEIPT OF MERCHANDISE. IF MERCHANDISE IS NOT FULLY PAID FOR AND CALLED FOR ON OR BEFORE IT WILL BE RETURNED TO STOCK UNLESS SPECIAL ARRANGEMENTS ARE MADE WITH THE MANAGER.

SOLD BY \_\_\_\_\_

**TL201** – Large Three Section Layaway Tag made of heavy manilla stock. Printed on both sides. Giant 8-1/2" long by 3-1/2" wide. 500 per box.

## SELF-STICKING LABELS

No Moistening Required. Just Peel and Stick On.



S2 – Special Sticker



S3 – Sale Price Sticker



S4 – Round Sale Stickers

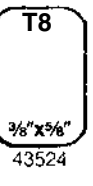
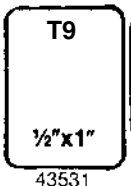
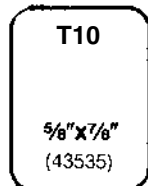
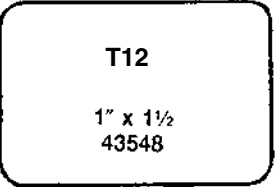
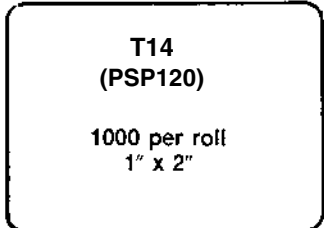

BLANK, WHITE, SELF-ADHESIVE LABELS  
IN A COMPLETE RANGE OF SIZES!

# TAGS & TICKETS

## BUTTON SLOT ALTERATION TAG

**BACK**

**COAT**

Shorten Sleeve	Lengthen Sleeve
Raise Collar	Lower Collar
Full Shoulder	Nice
Shorten Coat	Widen Skirt
Take in Side	Let out Side

**FRONT**

**MEN'S ALTERATION TAG**

**STATE ALTERATIONS ON BACK**

Date \_\_\_\_\_

Name \_\_\_\_\_

Address \_\_\_\_\_

Garment	Price	Tax	Alt.	Total
Sold by				Paid
To be Done				Due

When Call \_\_\_\_\_

Remarks \_\_\_\_\_

OVER \_\_\_\_\_

Date \_\_\_\_\_

Garment	Price	Tax	Alt.	Total
Sold by				Paid
When Finished				Due

NO GOODS DELIVERED WITHOUT THIS CHECK

**B1002** — Two section alteration tag. Button slot feature allows you to slip over button. 6 1/2" x 3 1/8".

## FOLDING PIN TICKETS

WHITE STOCK.  
PRINTED BLACK.



White stock. Wire foldeover staple.  
3 sizes available

Style Dimensions  
**T836** — 5-1/8" H x 1-3/8" W  
**T837** — 5-3/8" H x 1-5/8" W  
**T838** — 6-1/8" H x 1-7/8" W

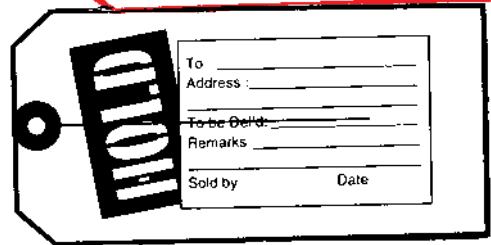

## CENTER SLOT—NO STRING

2 3/8" wide x 4 3/4" long  
**STT4** — Sold Ticket is red on white  
**HTT4** — Hold Ticket is blue on white

## SUPER-DELUXE TAGS

— NO PERFORATION —

ALL TAGS SHOWN ACTUAL SIZE

**T437N** - No string  
**T437S** - Strung

PRICE

**NO STRING**  
**T437N**  
**T337N**

**WITH STRING**  
**T437S**  
**T337S**

# PINS & NEEDLES

### SAFETY PINS

Available in silver plated or brass plated.

Style No. 00 — Brass 3/4" long

Style No. 1 — Silver 1" long

Style No. 2 — Silver 1-1/2"



### STRAIGHT PINS

#20 1 lb. box 1 1/4"

#17 1 lb. box 1"

No. 20 — Standard  
 No. 17 — Extra Fine

### TAG NEEDLES

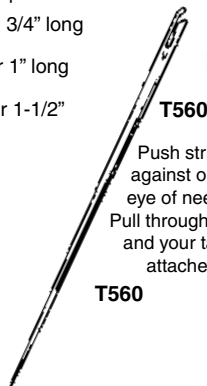

**T560**

Push string against open eye of needle. Pull through fabric and your tag is attached.

**T560**

### T PINS

Nickle plated  
 1/2 lb. box.

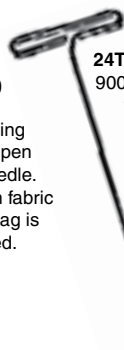

**24T** — 1-1/2" long.  
 900 pins per box.  
 1/2 lb. box.

## HOLE NO STRING

**T211N**  
**T212N**  
**T213N**  
**T214N**  
**T215N**  
**T216N**  
**T217N**  
**T218N**

## HOLE WITH STRING

**T211**  
**T212**  
**T213**  
**T214**  
**T215**  
**T216**  
**T217**  
**T218**

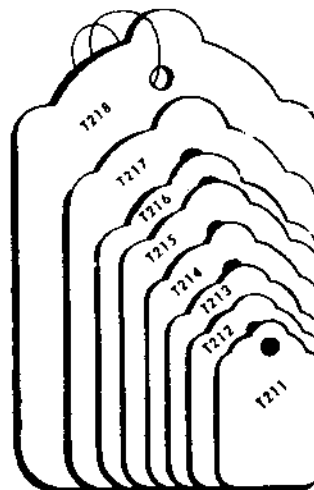

# SUPER DELUXE PERFORATED COUPON TAGS IN 3 SIZES

– 13 COLORS TO CHOOSE –

AVAILABLE WITHOUT STRING (FOR USE WITH TAG GUN ON PAGE 87 & 88) OR WITH STRING.

White, Yellow, Grey, Red, Lt. Blue, Buff, Pink, Brown, Dk. Green, Dk. Blue, Lavender, Orange, Lt. Green.

– PACKED 1000 PER BOX –

Actual Size

**T480N** ○  
**T480S**

No. \_\_\_\_\_

STYLE \_\_\_\_\_

SIZE \_\_\_\_\_

PRICE \_\_\_\_\_

---

No. \_\_\_\_\_

STYLE \_\_\_\_\_

SIZE \_\_\_\_\_

PRICE \_\_\_\_\_

"STANDARD" 1 3/4" x 2 3/4"

**T480N – No String**  
**T480S – Strung**

Actual Size

<b>T180N</b>	LOT	STYLE	SIZE	PRICE
<b>T180S</b>				

---

○	LOT	STYLE	SIZE	PRICE

"SLIM" 1 3/8" x 2 3/4"

**T180N – No String**  
**T180S – Strung**

**NO STRING**

T180N T480N T380N

**WITH STRING**

T180S T480S T380S

Prices  
Below Are  
Per 1000

Actual Size

**T380N** ○  
**T380S**

NO. \_\_\_\_\_

STYLE \_\_\_\_\_

SIZE \_\_\_\_\_

PRICE \_\_\_\_\_

---

NO. \_\_\_\_\_

STYLE \_\_\_\_\_

SIZE \_\_\_\_\_

PRICE \_\_\_\_\_

"SMALL" 1 1/4" x 2"

**T380N – No String**  
**T380S – Strung**

## PRINTED COUPON TAG

### STOCK COLORS

White, Gray, Red, Lt. Blue, Lt. Green,  
Buff, Pink, Yellow, Lavender, Orange,  
Dk. Blue, Dk. Green, Brown

When Ordering: Choose Stock Style Number, Size A, B or C, Stock Color, Indicate With or Without String and Style of Type.

Personalized logos and printing on price tags T480, T380, and T180 (above), T437 and T337 (page 91). It's great advertising to identify your store. Print as many lines or logo that can fit on tag. Logos should be camera ready. We can design a logo based on your design. Call our art dept. extension 104 for details. Prices below includes black color printing and choice of one color tag. One time \$35.00 plate charge. Optional costs: \$22.50 additional for red, blue, green or brown ink. \$20.00 for adding a second color tag. Minimum order 5000 tags.

Styles of type shown can be printed on any stock style number shown below.

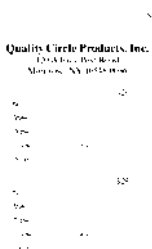

Design #292

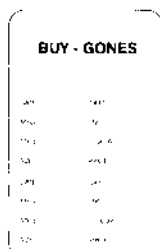

Design #293

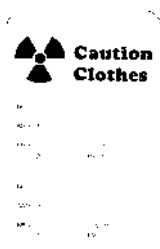

Design #294

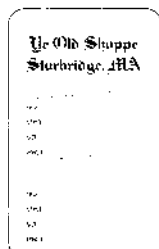

Design #295

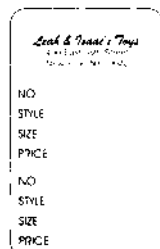

Design #296



Design #298

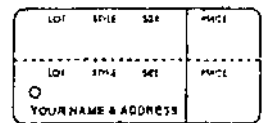

Design #299

### STOCK TAG STYLES & SIZES

Style 292-298 are Available in 2 Sizes

Size A – 1-3/4" Wide x 2-7/8" High (Style T480, T437)

Size B – 1-1/4" Wide x 1-7/8" High (Style T380, T337)

Style 299 is in One Size Only

Size C – 1-3/8" High x 2-7/8" Long (Style T180)

1000 per box.

# SALE TAGS



**NO STRING**  
No. 50N, No. 40N, No. 60N



1-3/4" x 2-1/2" High  
**RED on WHITE STOCK**



**WITH STRING**  
No. 50S, No. 40S, No. 60S



RED ON WHITE  
1-3/4" x 2-3/4" High

**NO STRING**  
No. 367N, No. 10N

**WITH STRING**  
No. 367S, No. 10S



No. 33N – 2-5/8" x 4-1/4" high  
No. 33S – 2-5/8" x 4-1/4" high  
No. 31N – 2-1/8" x 3-1/4" high  
No. 31S – 2-1/8" x 3-1/4" high



**90N SALE PRICE**  
No String 1-1/4" x 1-7/8" High

**90S SALE PRICE**  
With String 1-1/4" x 1-7/8" High



## CLEAR PRESSURE SENSITIVE MERCHANDISING HANGERS

Made of co-polyester clear plastic. Special adhesive allows the hanger to adhere to the backs of packages for display on peg hooks, walls, ceilings, etc. Choice of 4 sizes. Bulk packed. Sticks on anything – paper, metal, plastic.

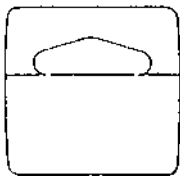

**#4 Sen**  
1-5/8" wide x 1-3/8" high



**#5 Sen**  
1-1/6" wide x 1-3/4" high



**#3 Sen**  
1" wide  
x 1-3/8" high

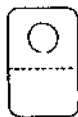

**#1 Sen**  
5/8" wide  
x 1-5/8" high

## JEWELRY TAGS

All purpose jewelry tags available with burgundy color silk like string or white cotton string. White stock. Also, preprinted Sale Jewelry tag now available. (See below).



T658

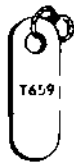

T659

Actual  
Size

### DELUXE SILK STRUNG

T658S  
T659S  
T656S  
T657S



T656



T657

### COTTON STRUNG

T656C  
T657C

### REGULAR PRICE/SALE PRICE SILK STRUNG JEWELRY TAG

T656RS

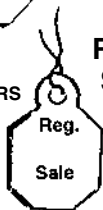

Reg.

Sale

T656RS

## ORECK UPRIGHT

**XL2000**



- Light weight, only 8 pounds.
- Exclusive handle has built in power switch.
- Special handle eliminates squeezing of the hand.
- Patented Sani-Seal trapping system keeps dirt in the bag.
- Micro sweep technology adjusts automatically to any surface.
- Brushes whirl at twice the speed of other machines.
- Virtually no after dust.
- 35 foot power chord.
- 1 year warranty.

**XL2000 – Upright**

**PK2008 – Bags**

## JEWELRY RING TAGS

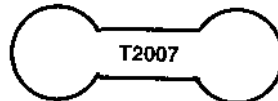

T2007

T2007 – White with self-adhesive ends. 7/16" x 1-5/16" long.

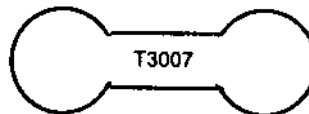

T3007

T3007 – White with self-adhesive ends. 9/16" x 1-11/16" long.

## CASIO ELECTRONIC CASH REGISTERS

**PCR-T273**

- Drop & load thermal printer
- 1-line operator LCD
- 1-line rear customer LCD display
- Cash drawer
- 8 department keys / 24 departments
- 8 clerk numbers
- 4 tax rates
- Built in all purpose tray
- Uses 2-1/4" thermal paper (58MM)

**PCR-T273 – Register**



**PCR-T500**

- Drop & load thermal printer
- 10-line tilt adjustable operator LCD
- Pop-up 2-line customer display
- Cash drawer
- 25 department keys / 200 departments
- 40 clerk numbers
- 4 tax rates
- Reports (3 report periods)
- Programmable post & logo messages (4 lines each)

**PCR-T500 – Register**



# PLASTIC LOOP SHOPPERS

3 sizes, choice of colors. 2.5 mil thick heavy duty matching loop handles. Cardboard top & bottom. 300 per box.



**CUB** – 8" wide x 10" high with 4" side gussets  
**PB1** – White      **PB1C** – Clear  
**PB1R** – Red      **PB1T** – Thank You design

**VOGUE** – 16" wide x 12" high, 6" side gussets  
**PB2** – White      **PB2C** – Clear  
**PB2R** – Red      **PB2T** – Thank You design

**QUEEN** – 16" wide x 18" high, 6" side gussets  
**PB3** – White      **PB3C** – Clear  
**PB3R** – Red      **PB3T** – Thank You design

# PATCH HANDLE BAGS

3 sizes, choice of colors.  
**PH1** – 1.5 mil. **PH2, PH3** – 1.75 mil



**PH1** – 9" wide x 12" high. (Use for accessories.)  
**PH1** – White  
**PH1R** – Red  
**PH1T** – Thank You design (5 languages)

**PH2** – 15" wide x 18" high, 4" bottom gusset.  
 (Use for blouses, pants, dresses.)  
**PH2** – White      **PH2B** – Black  
**PH2R** – Red      **PH2C** – Clear  
**PH1T** – Thank You design (5 languages)

**PH3** – 20" wide x 20" high, 5" bottom gusset.  
 (Use for suits, coats.)  
**PH3** – White  
**PH3T** – Thank You design (5 languages)

# T-SHIRT BAGS



**TSB2** – 12" wide x 23" high, 7" side gusset.  
 .0006 mil, 1000 per box.  
**TSB2** – White  
**TSB2B** – Black

**TSB3** – 18" wide x 34" high, 9" side gusset.  
 .0008 mil, 500 per box.  
**TSB3** – White

*Printing available on all stock bags – call for pricing.*

# PLASTIC SHOPPING BAGS

- Great selection of frosted colors. • In stock for immediate shipment.
- Printing available, call for pricing. • All Shopping bags have cardboard bottoms.
- 3 mil heavy tri-fold. • Flexiloop matching color handles.

## TRI-FOLD SHOPPERS

3 sizes, choice of 6 colors.



**CUB** – 8" wide x 10" high, 4" side gussets  
**TFSC** – Frosty clear      **TFSB** – Black  
**TFSBL** – Blue            **TFSSS** – Silver  
**TFSG** – Grape            **TFSCS** – Cerise

**VOGUE** – 16" wide x 12" high, 6" side gussets  
**TFS2C** – Frosty clear      **TFS2B** – Black  
**TFS2BL** – Blue            **TFS2SS** – Silver  
**TFS2G** – Grape            **TFS2CS** – Cerise

**QUEEN** – 16" wide x 18" high, 6" side gussets  
**TFS3C** – Frosty clear      **TFS3B** – Black  
**TFS3BL** – Blue            **TFS3SS** – Silver  
**TFS3G** – Grape            **TFS3CS** – Cerise

## FLEXI LOOP SHOPPERS

4 sizes, frosted clear.



Queen

Vogue

Junior Cub

**JUNIOR CUB** – 5" wide x 8" high, 3" side gussets  
**FL5** – Frosty Clear

**CUB** – 8" wide x 10" high, 4" side gussets  
**FL8** – Frosty Clear

**VOGUE** – 16" wide x 12" high, 6" side gussets  
**FL16** – Frosty Clear

**QUEEN** – 16" wide x 18" high, 6" side gussets  
**FL18** – Frosty Clear

*Printing available on all stock bags – call for pricing.*

# DIE CUT MERCHANDISE BAGS

Die cut bags are available in frosty clear or white.



## WHITE

2 mil at top, 1 mil at bottom

**PB9** – 9" wide x 12" high

**PB12** – 12" wide x 15" high

**PB15** – 15" wide x 18" high, 4" bottom gusset.

## FROSTY CLEAR

2.5 mil thick, 500 per box.

**FC9CLE** – 9" wide x 15" high

**FC12CLE** – 12" wide x 15" high

**FC15CLE** – 14" wide x 21" high, with 3" gussets.



## POLY DRAW STRING BAGS

Bags are 1.5 mil thick. 1000 per box. 16" wide x 18" high, 3" bottom gusset.

**PDS** – White

**PDST** – Thank You design

(Call for printing pricing.)



## DRAW STRING BAGS

Clear draw string bag. Heavy duty 2 mil with heavy cotton draw string.

### DS1318

13" x 18" x 4" bottom gusset.  
500 per box.

### DS1822

18" x 22" x 4" bottom gusset.  
500 per box.

# PAPER SHOPPING BAGS

Tan or matte white kraft color. 3 sizes.



**CUB** – 8" wide x 10" high, 4" side gussets  
**TSB10** – Tan **TSB10W** – White

**VOGUE** – 16" wide x 12" high, 6" side gussets  
**TSB12** – Tan **TSB12W** – White

**QUEEN** – 16" wide x 19" high, 6" side gussets  
**TSB** – Tan **TSBW** – White



Gloss-Laminated Eurototes

## DELUXE SHOPPERS

High gloss black or white bags.  
 Matching 18" poly pro rope handles. 3 sizes, 2 colors

**HGL46B** – Black  
**HGL46W** – White  
 6-1/2" wide x 6-1/2" high, 3-1/2" side gusset.

**HGL410B** – Black  
**HGL410W** – White  
 8" wide x 10" high, 4" side gusset.

**HGL612B** – Black  
**HGL612W** – White  
 16" wide x 12" high, 6" wide.

## TWO PIECE AUTOMATIC FLIP UP GIFT BOXES

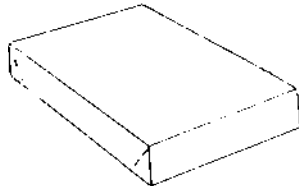

SIZE	Boxes Per Carton	Use
10"x7"x1"	200	Infants, Children's Wear
11"x8"x1-1/2"	100	Lingerie, Children's Wear
15"x9-1/2"x2"	100	Ladies' Wear, Long Fold Shirts
17"x11"x2-1/2"	50	Jackets, Dresses, Robes
19"x12"x3"	50	Robes, Suits, Jackets
24"x14"x4"	25	Furs, Coats

AVAILABLE IN SPARKLE WHITE OR NATURAL KRAFT PINSTRIPE DESIGN (LIGHT BROWN COLOR).

YOU CAN COMBINE SIZES FOR QUANTITY PRICE.

White	Natural Kraft
<b>GW07</b>	<b>GG07</b>
<b>GW09</b>	<b>GG12</b>
<b>GW15</b>	<b>GG15</b>
<b>GW17</b>	<b>GG17</b>
<b>GW19</b>	<b>GG19</b>
<b>GW24</b>	<b>GG24</b>

**PRINTING:** 1st Order Plate Charge Billed At Cost  
 \$95.00 per 1000 Printing Charge



## GOLD OR SILVER STRETCHIES

WITH PRE-TIED BOWS

**M235** – GOLD  
**M311** – SILVER

## GIFT PAPER CUTTERS

Each unit comes with four 3/4" screws and four running bumpers. Available to hold single, double, or triple rolls.

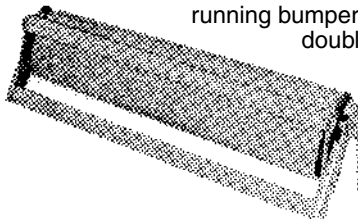

### SINGLE ROLL CUTTER

STYLE	SIZE
<b>PC 24</b>	<b>24"</b>
<b>PC 30</b>	<b>30"</b>

## TISSUE PAPER

High quality gift or packing tissue. Available in pink or white.

**HG1** – WHITE TISSUE 17" X 27"  
**HG2** – PINK TISSUE 17" X 27"

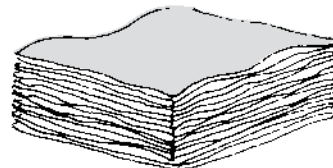

480 SHEETS PER REAM  
 (2 REAMS PER PACKAGE)  
 For other colors, call for samples!!



SHIP TO \_\_\_\_\_  
 ADDRESS \_\_\_\_\_  
 CITY \_\_\_\_\_ STATE \_\_\_\_\_ ZIP \_\_\_\_\_  
 ORDERED BY \_\_\_\_\_ YOUR P.O. NO. \_\_\_\_\_ TELEPHONE ( \_\_\_\_\_ ) \_\_\_\_\_  
 BILL US     CHECK ENCLOSED     AMERICAN EXPRESS     VISA/MASTERCARD     DISCOVER

QUANTITY	ITEM NO.	DESCRIPTION	PRICE	AMOUNT

CREDIT CARD NUMBER \_\_\_\_\_  
 EXPIRATION \_\_\_\_\_ CODE \_\_\_\_\_  
 NAME ON CARD \_\_\_\_\_

<b>TOTAL MERCHANDISE</b>	
<b>DEDUCT 5% of order if prepaying by check</b>	
<b>FedEx, UPS or freight will be added to bill</b>	
<b>TOTAL AMOUNT</b>	



**WE ACCEPT AMERICAN EXPRESS, VISA, MASTERCARD & DISCOVER**



**TERMS \* CREDIT \* ORDERING \* SHIPPING**

“You can be assured that all products shown in this catalogue are made of the finest materials available”

**Order by Website:** Leave your orders on our website at [www.americanhanger.com](http://www.americanhanger.com). All orders are processed the same day. 90% of all orders are shipped the same day. We will confirm your order by email and provide you with a tracking number and an order number for your records.

**Order by Mail:** Orders received through the mail should be accompanied either by a check or a money order for goods purchased. If you wish credit send credit references so that we may establish a credit rating for your firms. Terms are Net 30 Days. American Hanger & Fixture Corporation, 687 Lehigh Avenue, Union, N.J. 07083.

**Order by Phone:**  
 Toll Free (800) 221-2790, N.J. (908) 688-6100

**Orders by Email:** Our email address is [sales@americanhanger.com](mailto:sales@americanhanger.com). Orders are received 24 hours a day.

**Orders by Fax:** (908) 687-1770. Our fax lines are ready 24-hours a day, seven days a week.

**Pick-Up:** Save On Freight. We maintain a 30,000 square foot warehouse in Union, N.J. Come down and see the products you want to purchase. Gather merchandising ideas by looking at our displays. Our efficient warehouse crew will be happy to load your truck or car. To facilitate pick-ups, call your orders in early and we can have the order ready for pick-up at our warehouse entrance at 687 Lehigh Avenue. We are open 8:30 AM – 5:00 PM Monday through Friday.

**Shipping:** 90% of all orders are shipped the same day. We have UPS and FedEx pick-up daily for quick efficient service. All items exceeding UPS limits will be shipped common carrier. Call for estimated shipping costs. All items are shipped FOB our New Jersey Warehouse. If you have a preferred carrier please indicate the carriers name. We ship freight collect unless you specify to ship prepaid and bill you.

**Returns:** Merchandise may be returned only after written authorization is received. Requests for authorization to make returns must be received within 15 days after shipping date. 15% restocking charge on all returns.

**Credit:** We check companies through D&B. If you are not listed in D&B, please provide 3 references and your bank for our credit manager to review. Terms are 30 days net.

**Credit Cards:** We accept Visa, Mastercard or American Express.

**Prepayments:** All orders prepaid by check or money order may be discounted 5%. Your order will be shipped upon receiving payment.

**Customer Care:** Any questions on your order can be answered by leaving an email for customer care or calling us and asking for a customer service person.

**Canceling Orders:** Call as soon as possible on non printed custom orders and if order has not been shipped we will cancel the order. Custom orders are not cancelable.

**Sales Tax:** Orders shipped out of N.J. State or N.Y. State are non taxable. Orders shipped in N.J. State or N.Y. State are taxable unless a resale number is provided to us at the time the order is placed.

**Rush Shipments:** We will ship overnight at your request. You must provide a fax or email to us indicating that you will pay for this service or charge freight to your account.

**Small Orders:** All orders for less than \$50.00 are subject to a \$5.00 handling fee.

**Due to inflationary pressures on our economy, all prices herein are subject to change without notice! Space limitations in this catalog prohibit the display of all merchandise we sell. If you don't see an item you desire, write or call or email for information.**

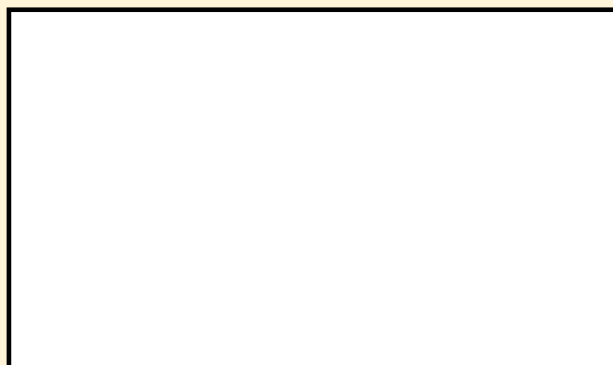



Presorted Standard  
U.S. Postage  
PAID  
Mechanicsburg, PA  
Permit No. 63



**PIPELINE FIXTURES**  
(See page 44-45)

Attn: SUPPLY/DISPLAY BUYER



**12/F  
PANTS FORM**  
(See page 72)

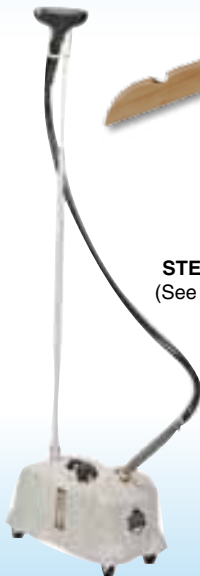

**STEAMERS**  
(See page 28)



**200N  
WOOD HANGERS**  
(See page 12-16)



**TAG GUNS &  
FASTENERS**  
(See page 88)

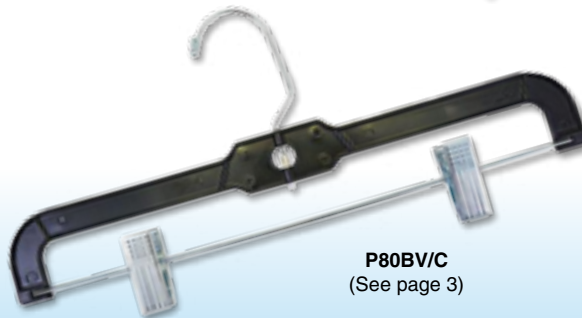

**P80BV/C**  
(See page 3)



**PRICE TAGS**  
(See page 91-94)

**[www.americanhanger.com](http://www.americanhanger.com)**

Toll Free (800) 221-2790 • NJ (908) 688-6100 • Fax (908) 687-1770

Email: [sales@americanhanger.com](mailto:sales@americanhanger.com)